

Product Configuration Guide

OSCILLATORS



- SPXO
- Programmable
- Spread Spectrum
- High Stability



Product Configuration System



Crystal Oscillators - SPXO

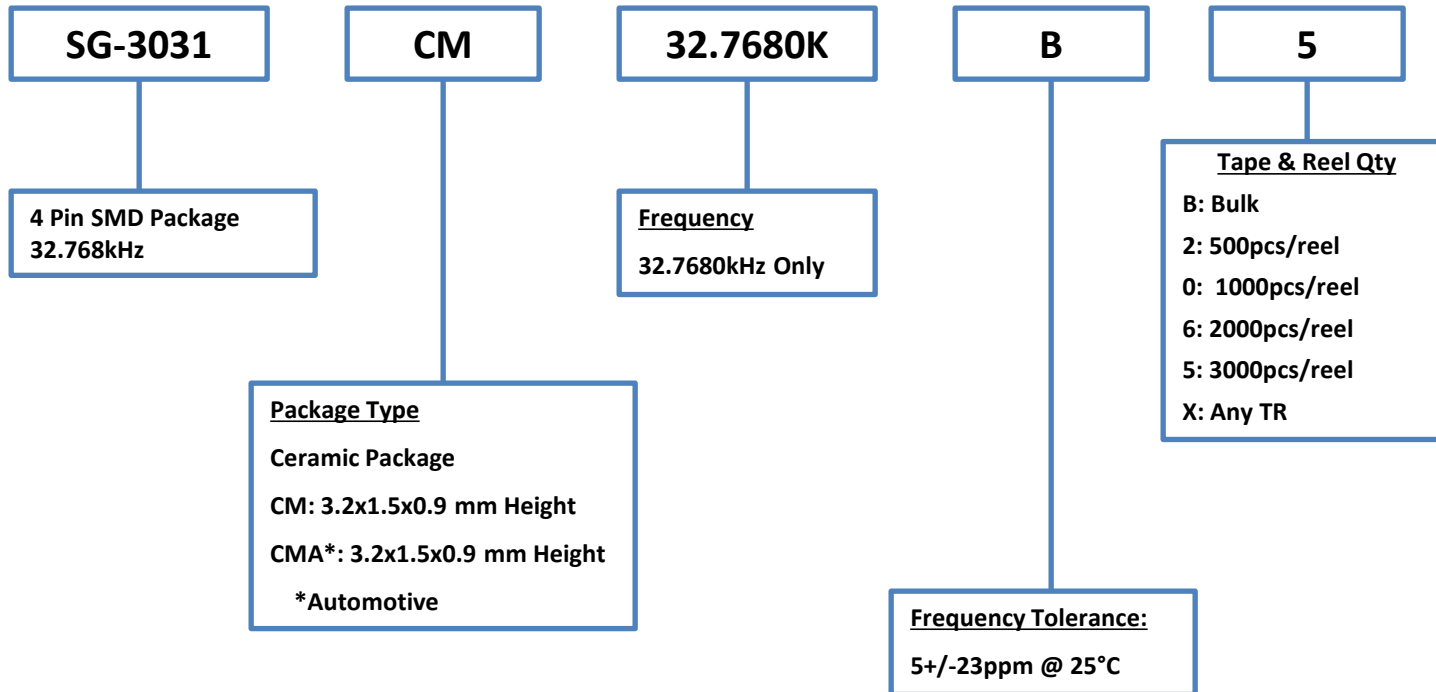

EPSON

August 2022

NOTE:

Please contact us for requirements not listed in this specification.

Product Configuration System



Crystal Oscillators - SPXO

Discontinued

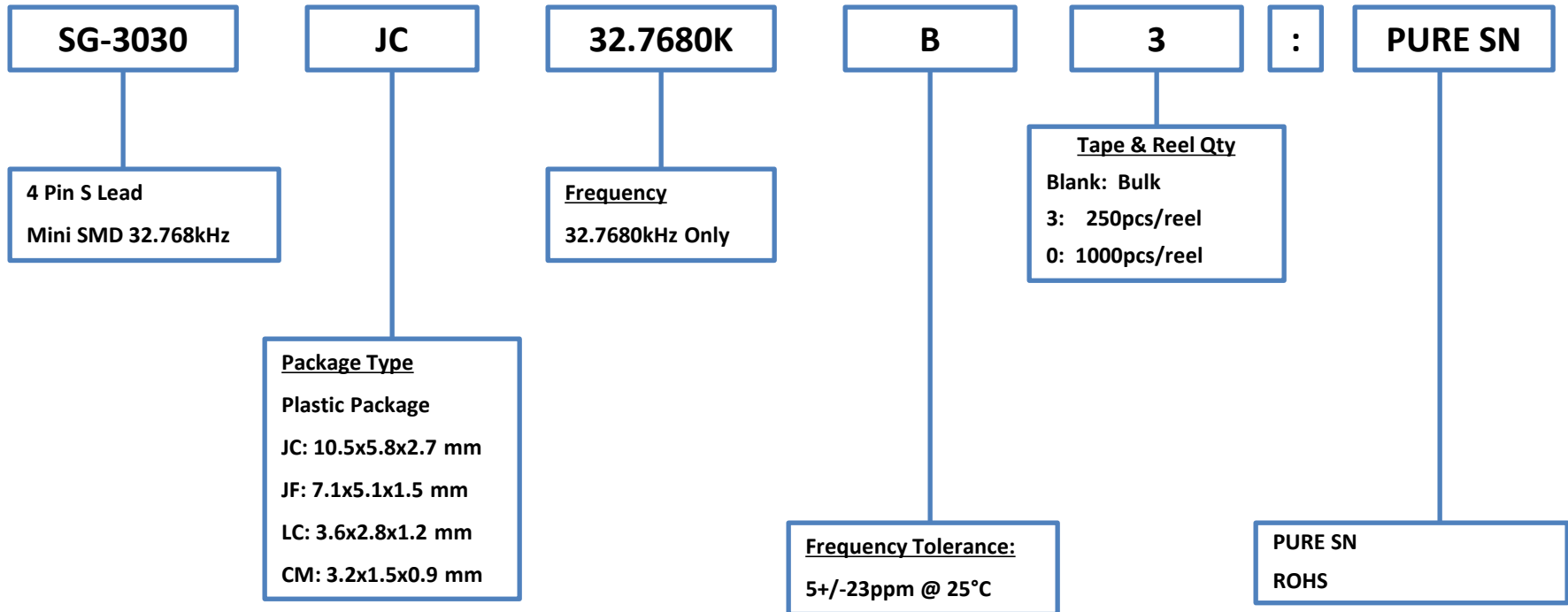

Note: All LC packages are RoHS Compliant, Pure SN

Product Configuration System



Crystal Oscillators - SPXO

Discontinued

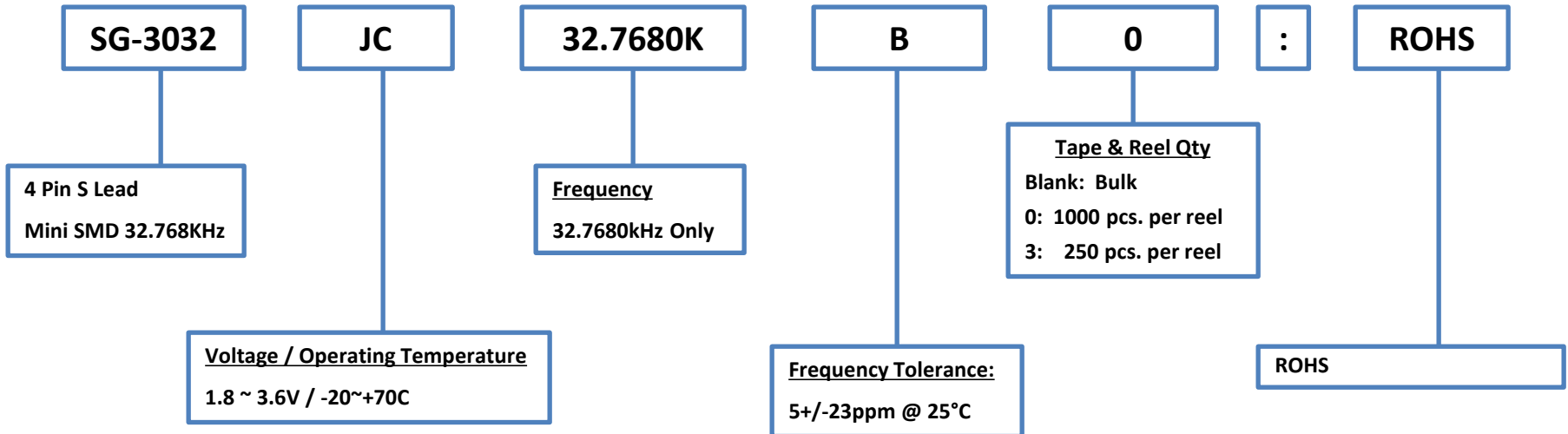

Product Configuration System



Crystal Oscillators - SPXO

Discontinued

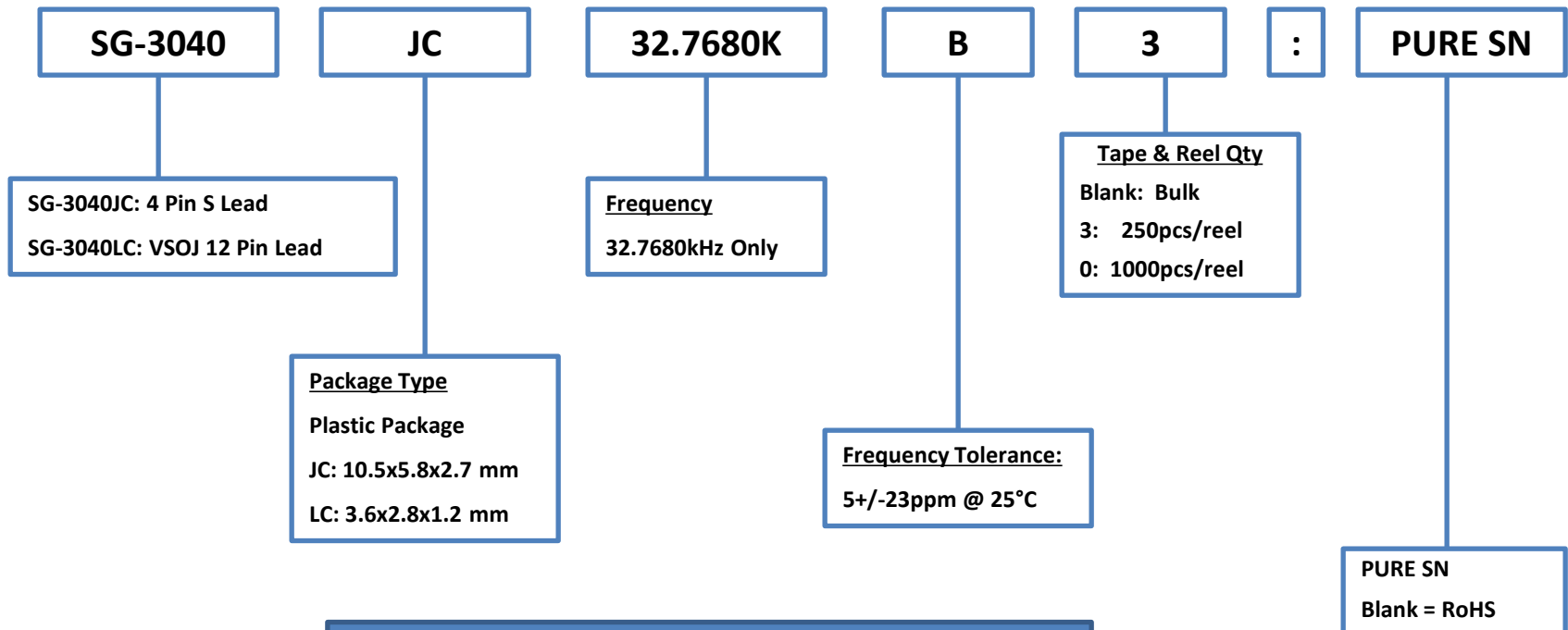

Note: All LC packages are RoHS Compliant, Pure SN

Product Configuration System



Crystal Oscillators - SPXO

Discontinued

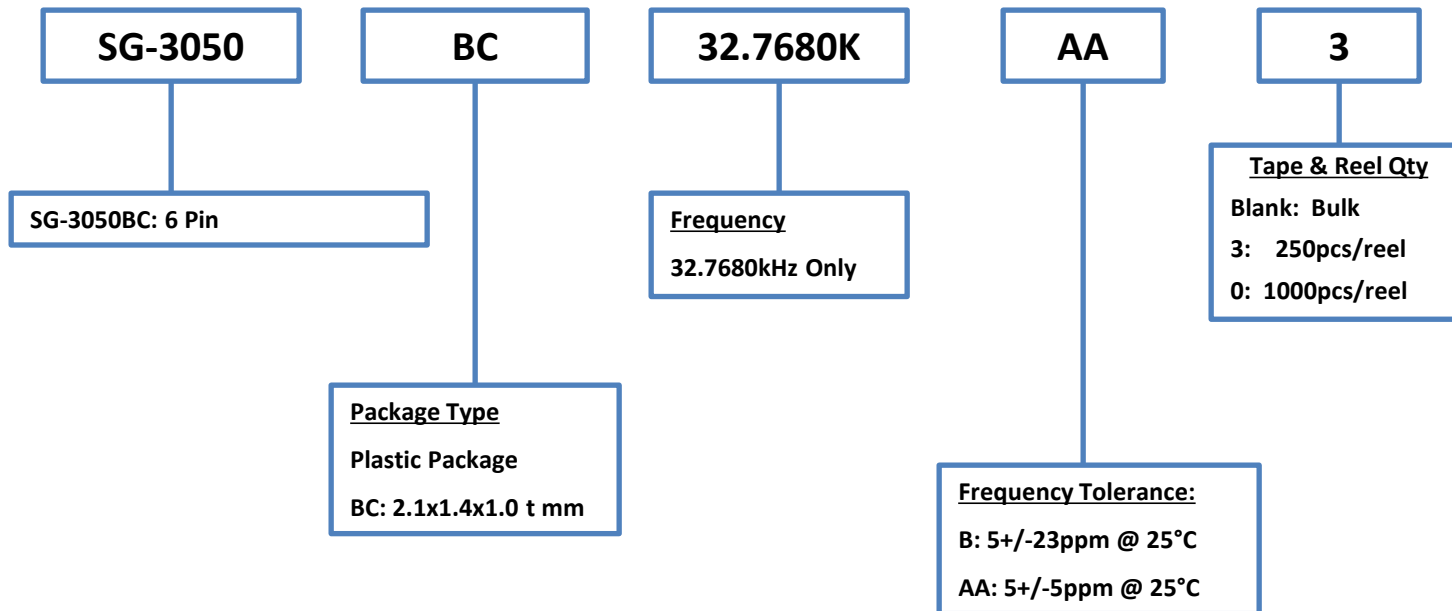

Product Configuration System



Crystal Oscillators - SPXO

Discontinued

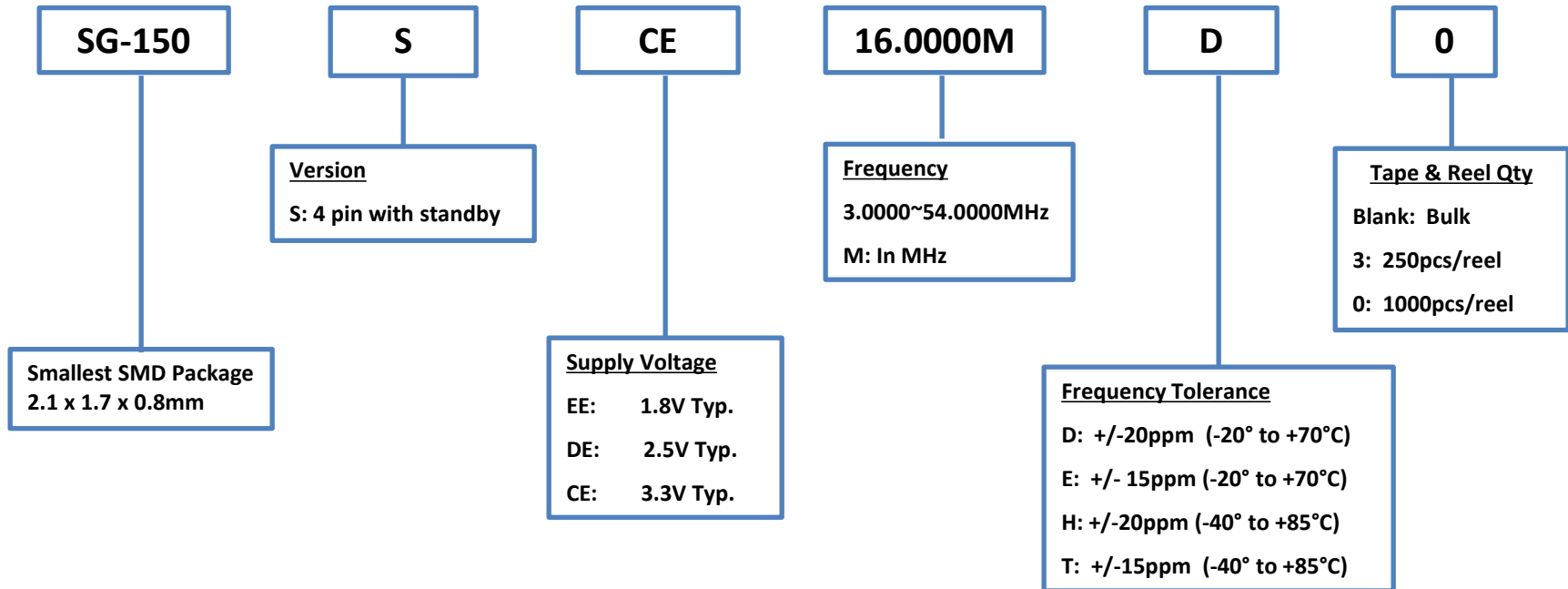

Product Configuration System



Crystal Oscillators - SPXO

Discontinued

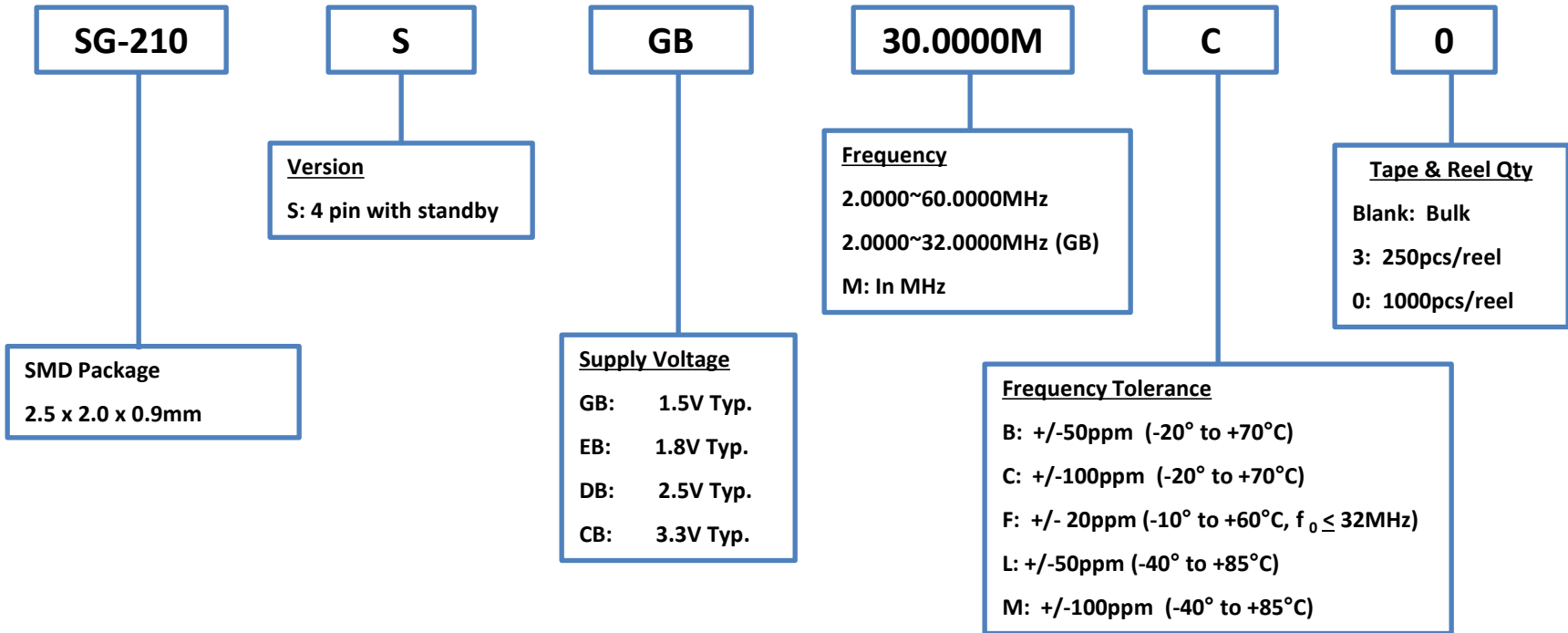

Product Configuration System



Crystal Oscillators - SPXO

Discontinued

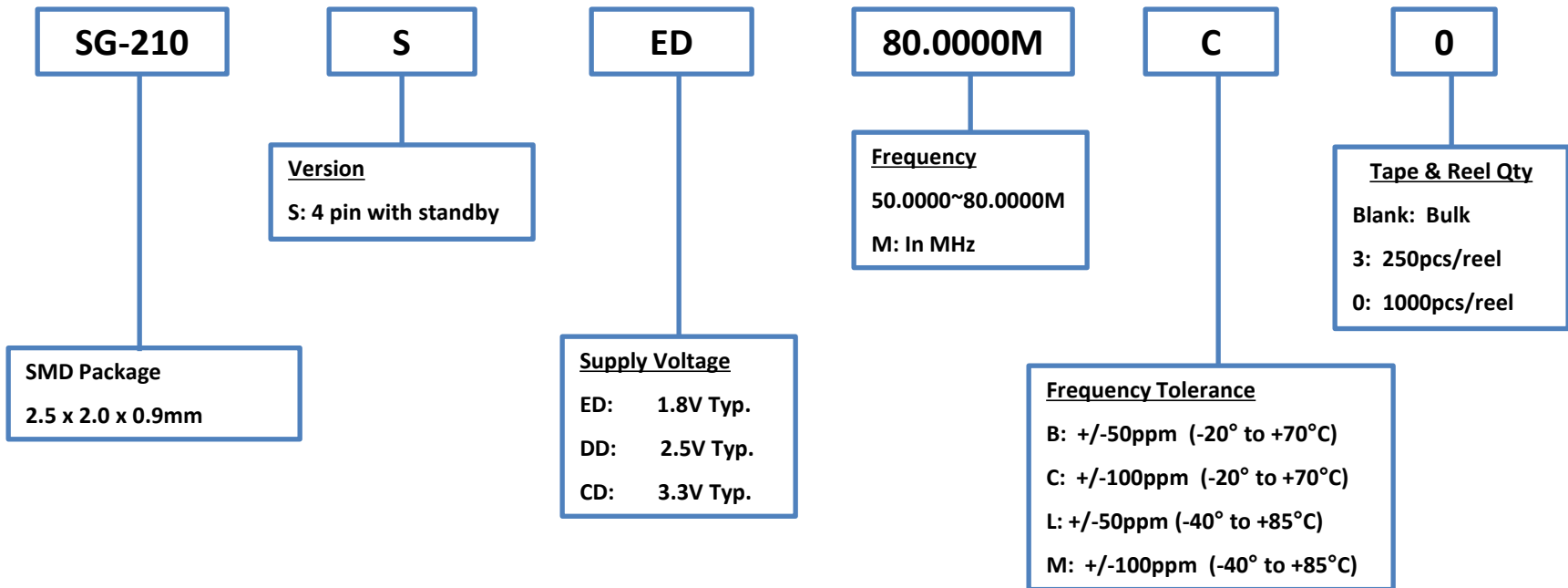

Product Configuration System



Crystal Oscillators - SPXO

Discontinued

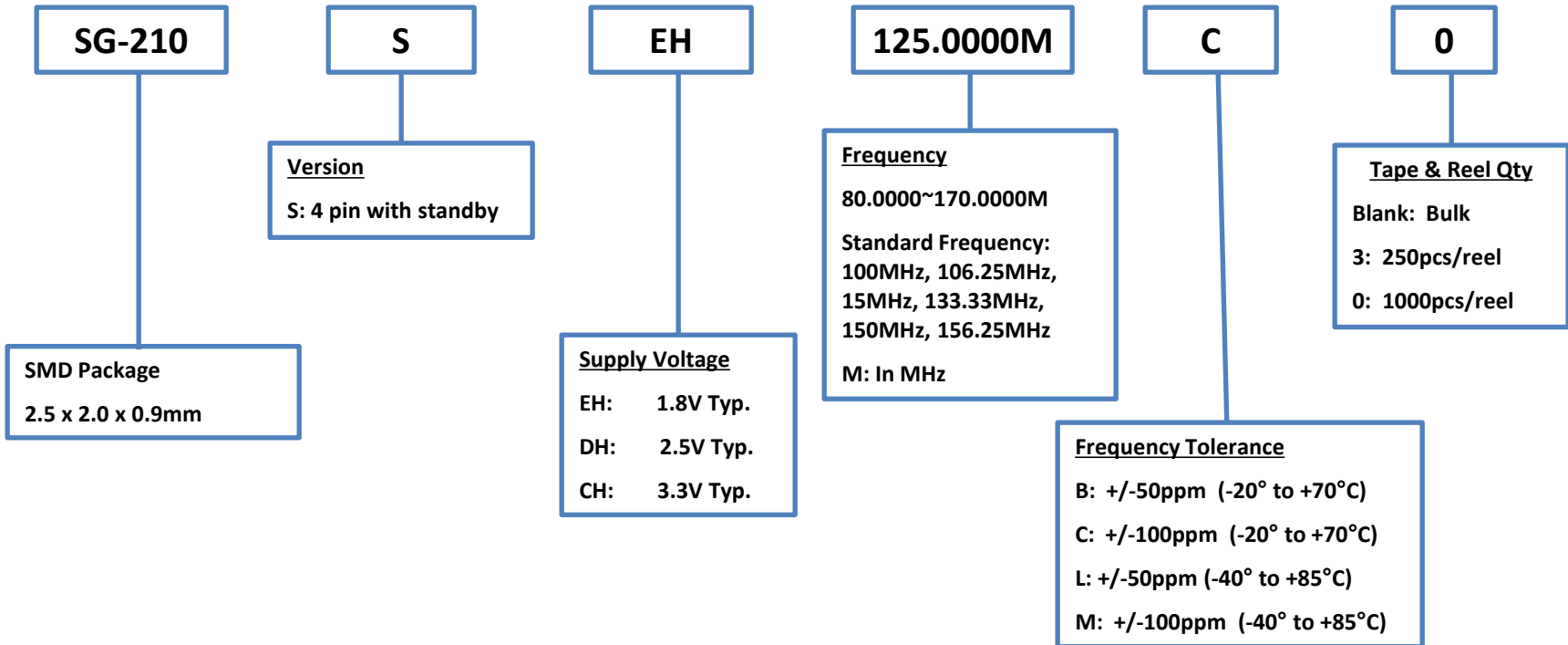

Product Configuration System



Crystal Oscillators - SPXO

Discontinued

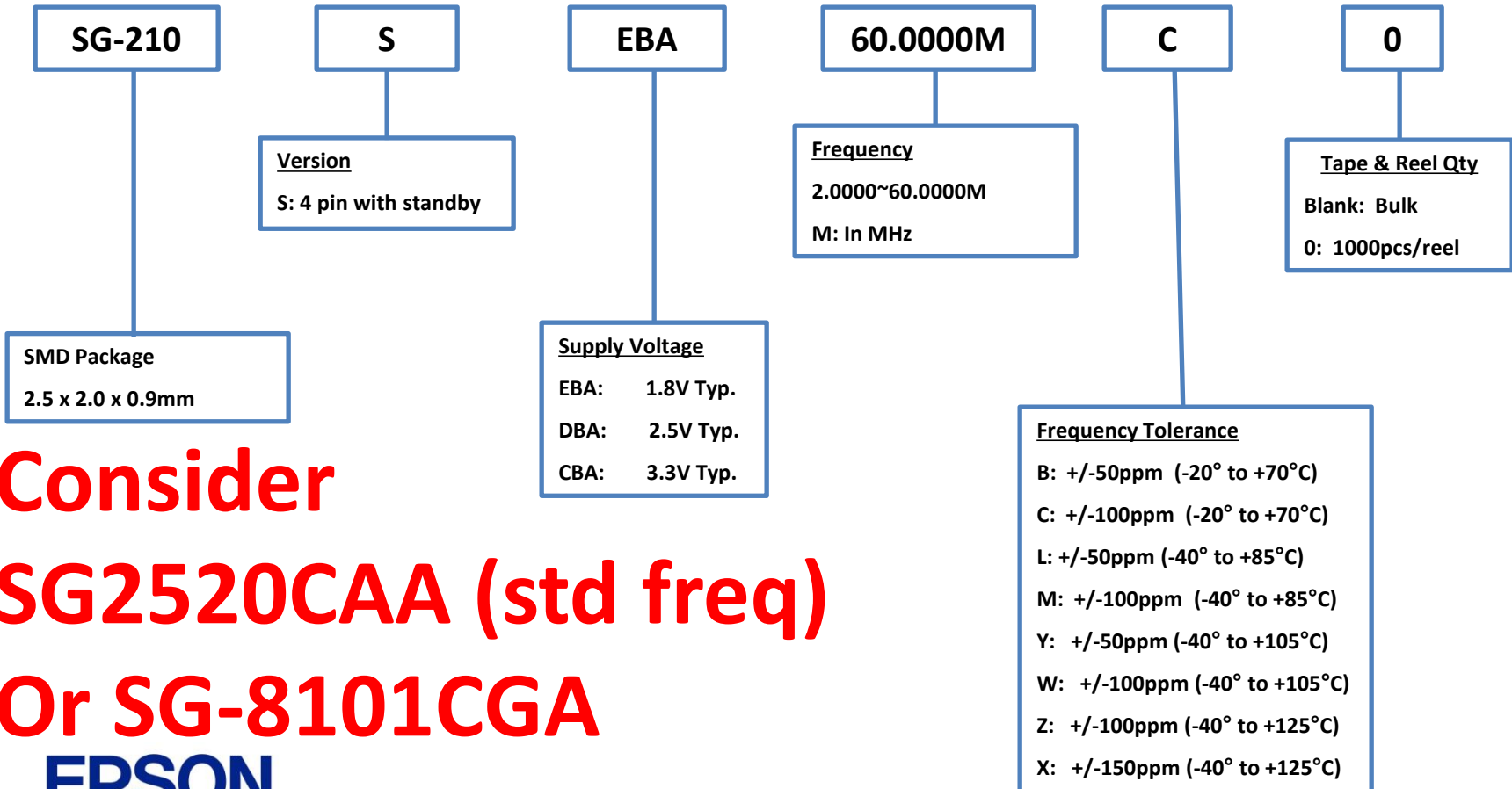

Consider
SG2520CAA (std freq)
Or SG-8101CGA
EPSON



Product Configuration System

Crystal Oscillators - SPXO

Discontinued

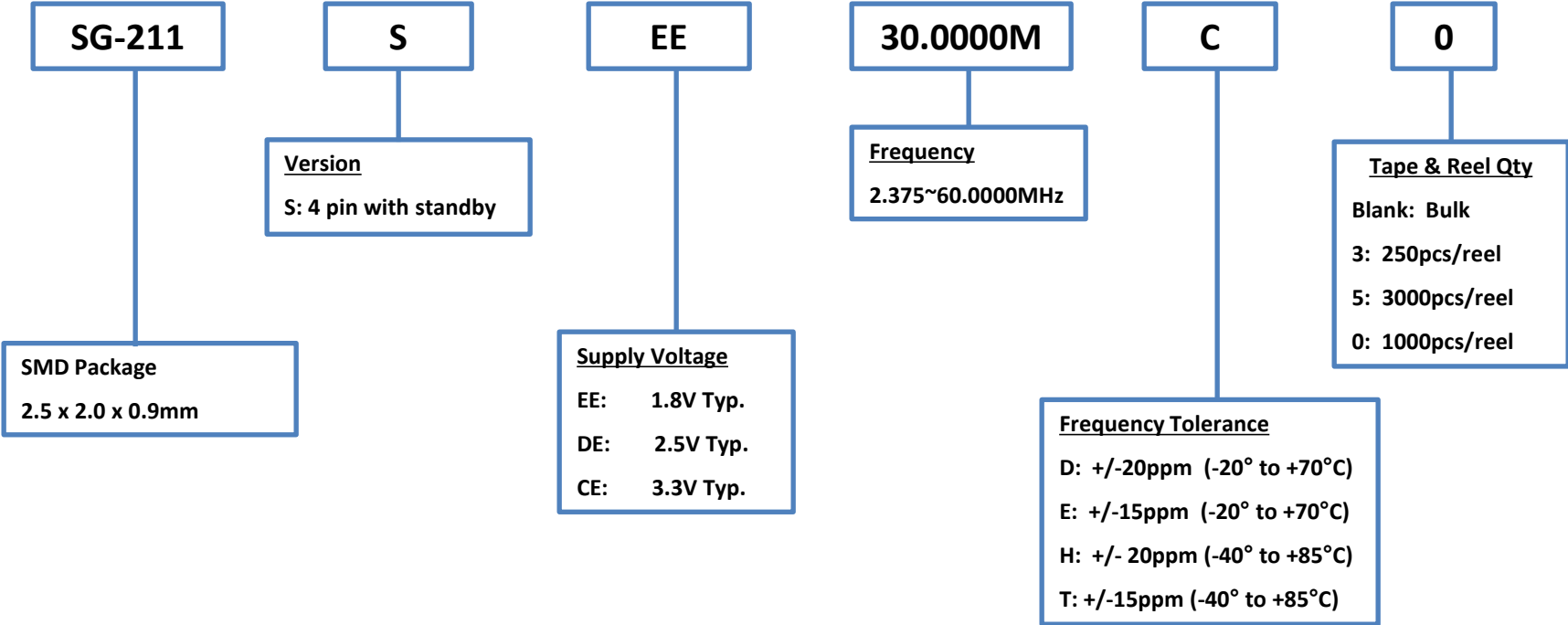

Product Configuration System



Crystal Oscillators - SPXO

Discontinued

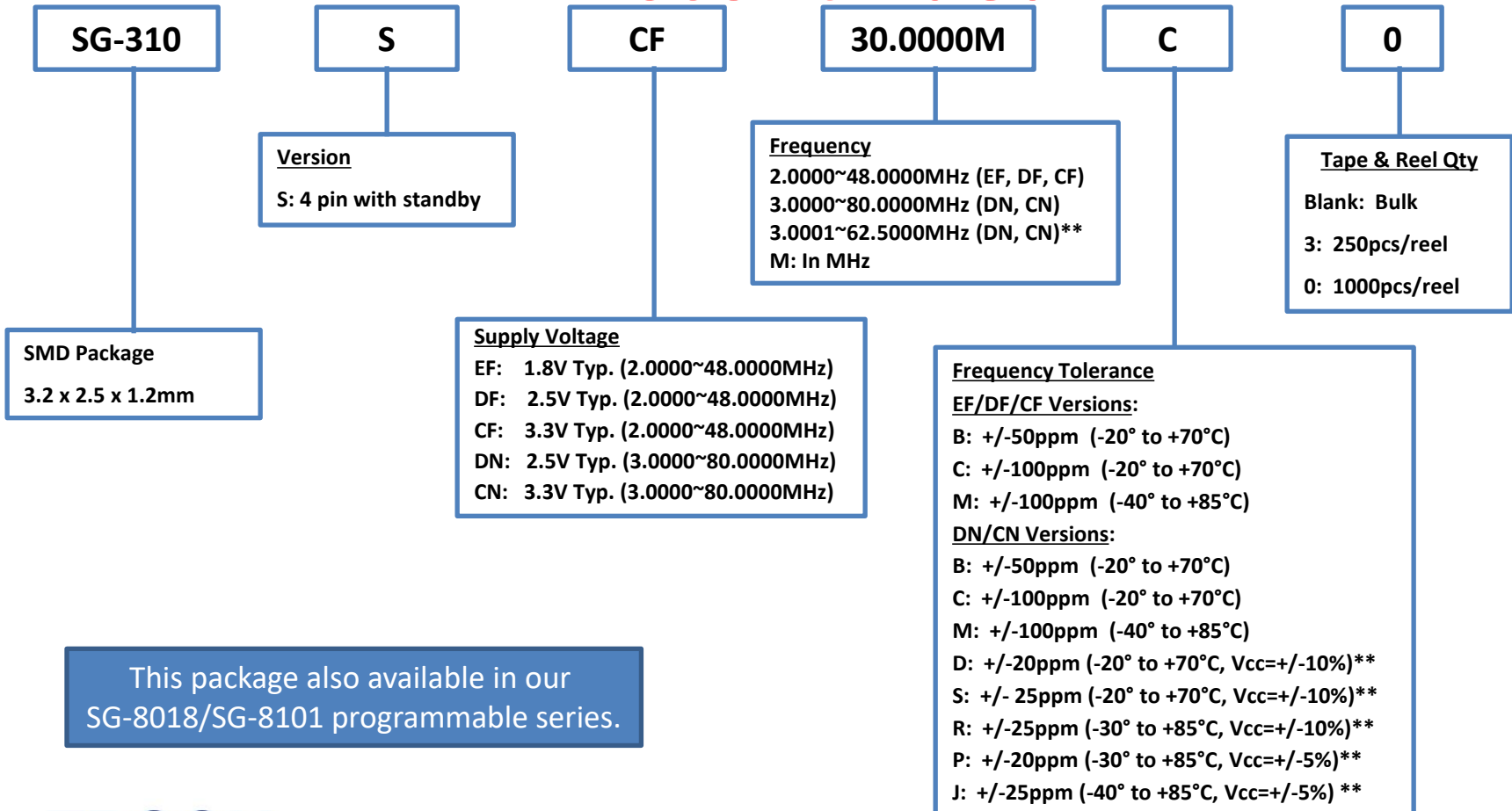

Product Configuration System



Crystal Oscillators - SPXO

Discontinued

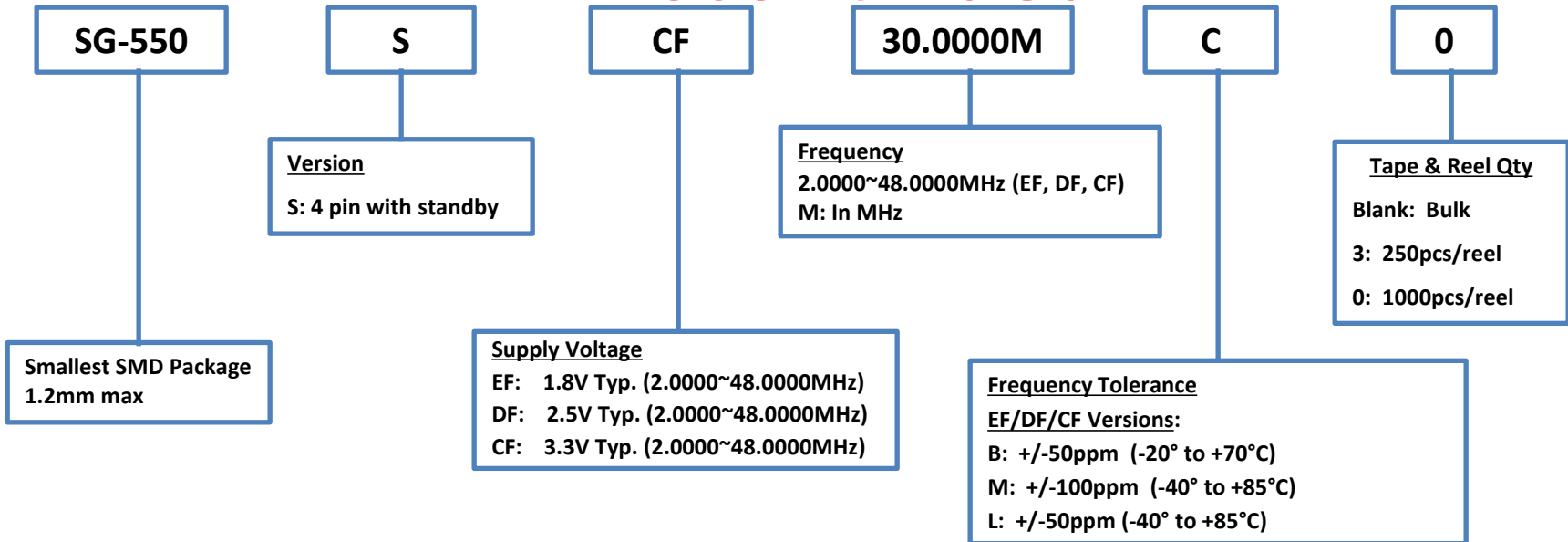

This package also available in our SG-8018/SG-8101 programmable series.



Product Configuration System



Crystal Oscillators - SPXO

Discontinued

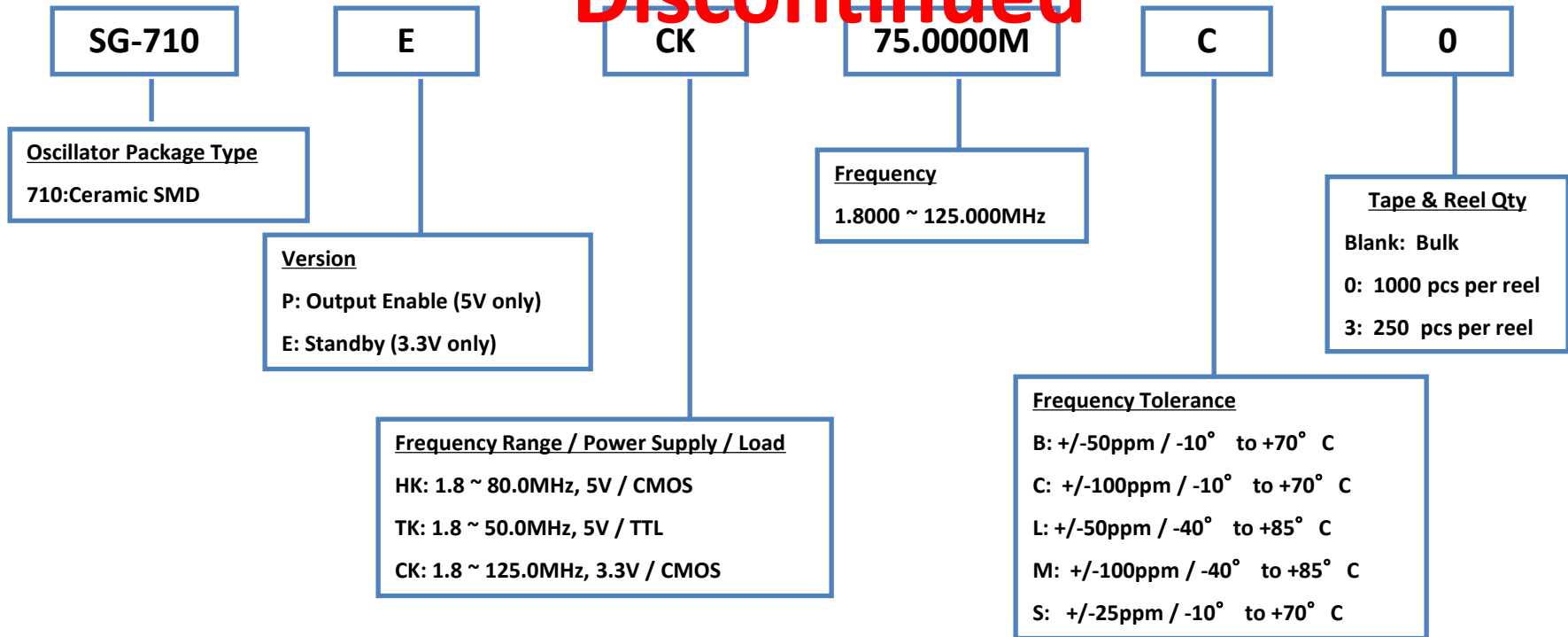

These packages also available in our SG-8018/SG-8101 programmable series.



Product Configuration System



Crystal Oscillators - SPXO

Discontinued

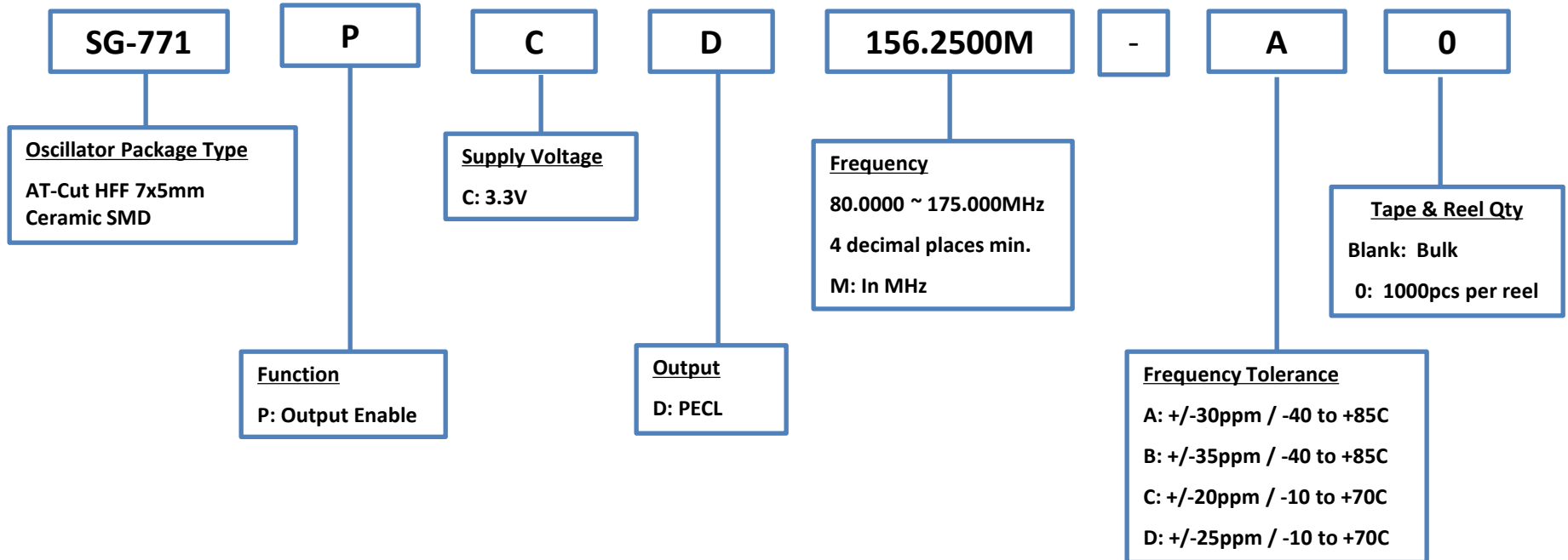

Product Configuration System



Crystal Oscillators - SPXO

Discontinued

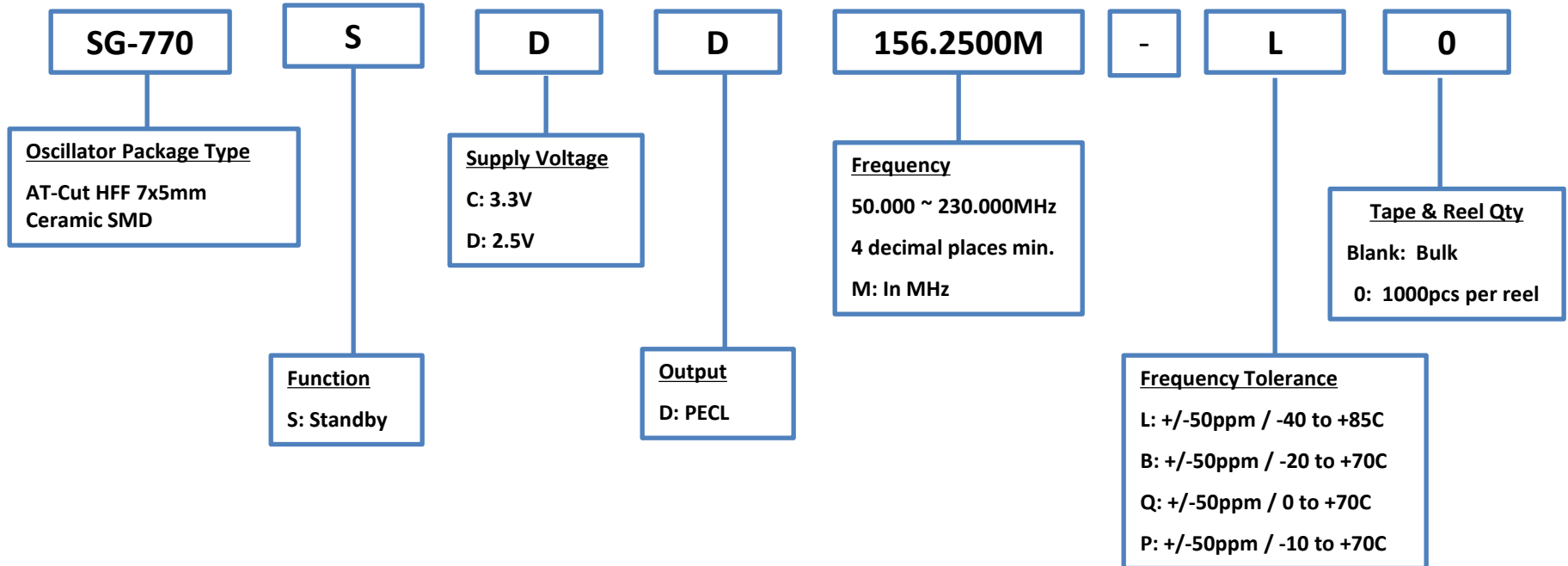

Replaces TCO-7116H1A



Product Configuration System

Crystal Oscillators - SPXO

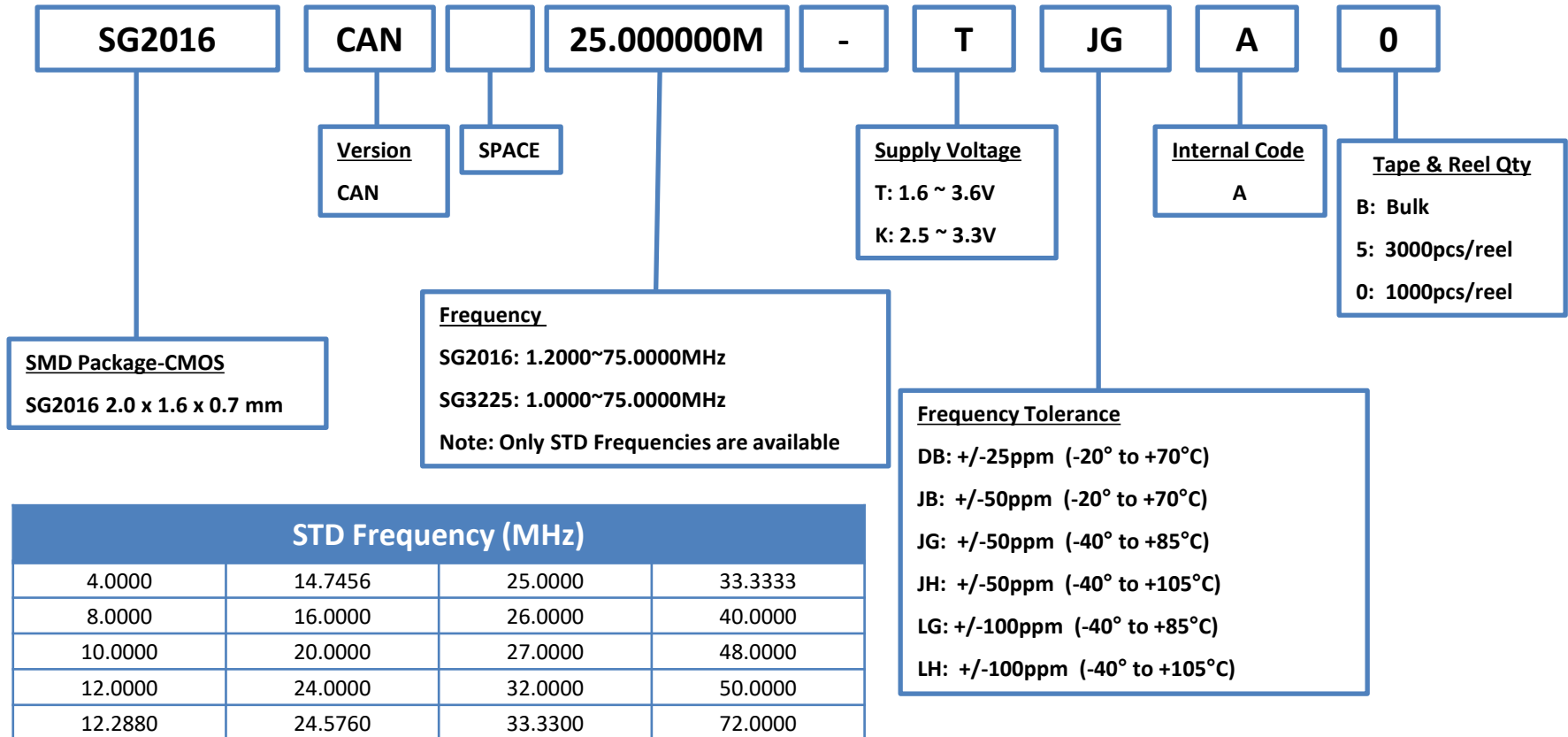

Product Configuration System



Crystal Oscillators – SPXO, Automotive

(Conforms to AECQ Requirement)

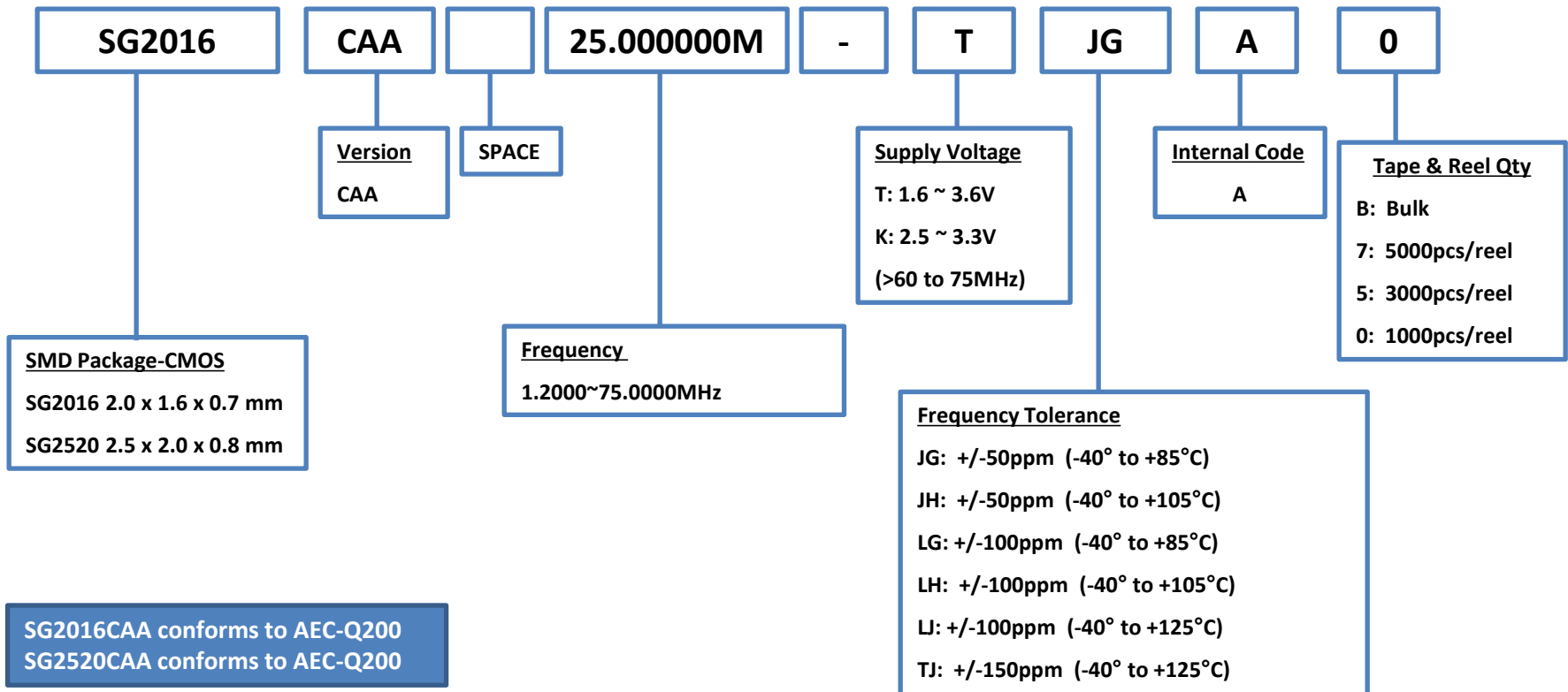

SG2016CAA conforms to AEC-Q200
SG2520CAA conforms to AEC-Q200

Example: SG2016CAA 25.0000M-TJGA7
Please contact us about available frequencies



Product Configuration System



Crystal Oscillators - SPXO

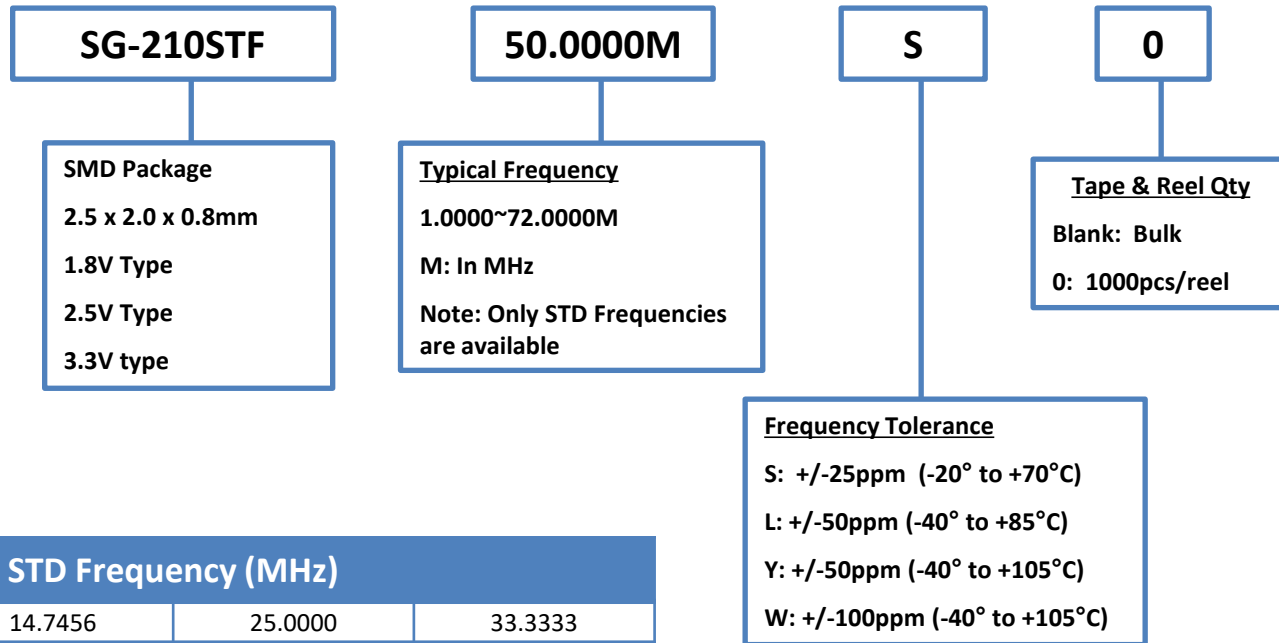

STD Frequency (MHz)			
4.0000	14.7456	25.0000	33.3333
8.0000	16.0000	26.0000	40.0000
10.0000	20.0000	27.0000	48.0000
12.0000	24.0000	32.0000	50.0000
12.2880	24.5760	33.3300	72.0000



For non-standard frequencies, please see SG-8018CG



Product Configuration System

Crystal Oscillators - SPXO

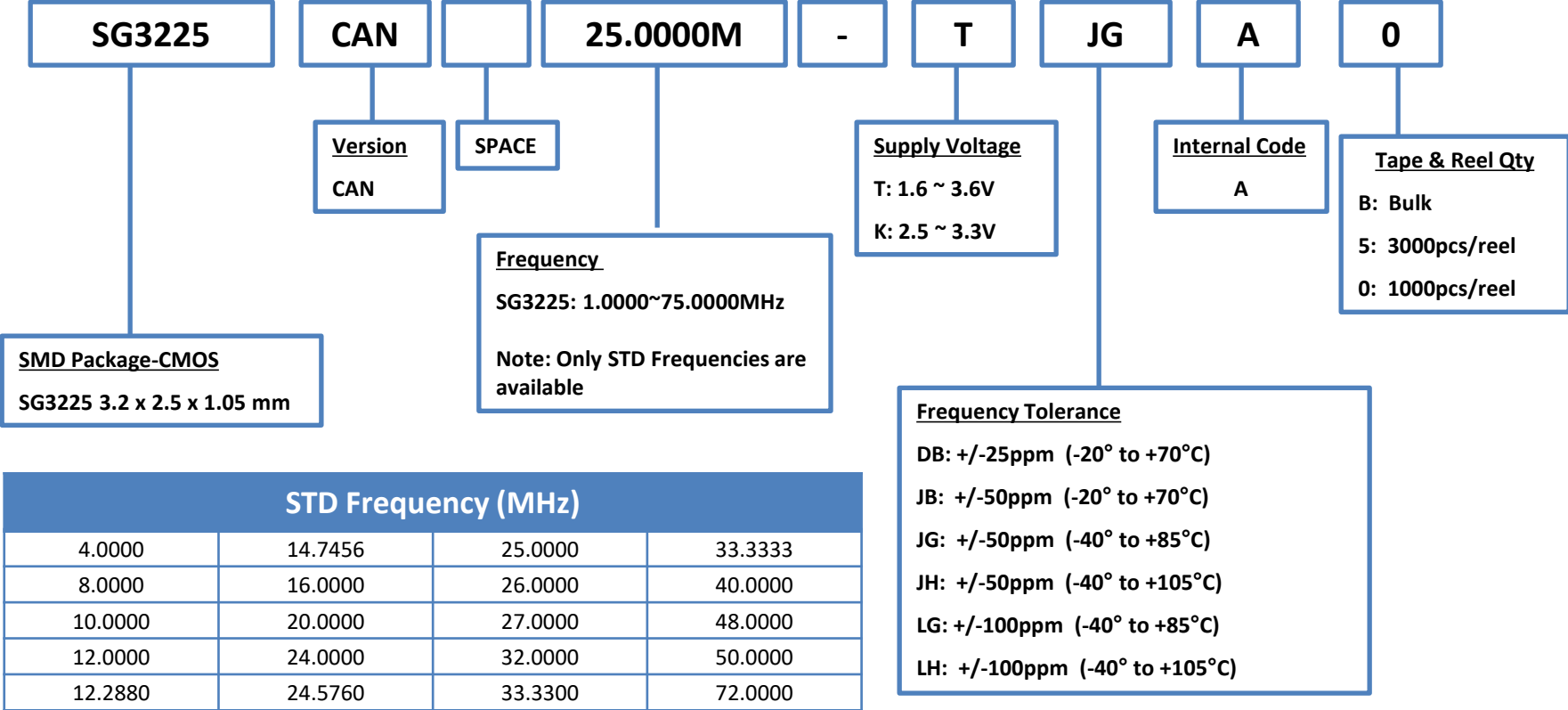

Example: SG3225CAN 25.0000M-TJGA

For non-standard frequencies, please see SG-8018CE



Product Configuration System

Crystal Oscillators - SPXO

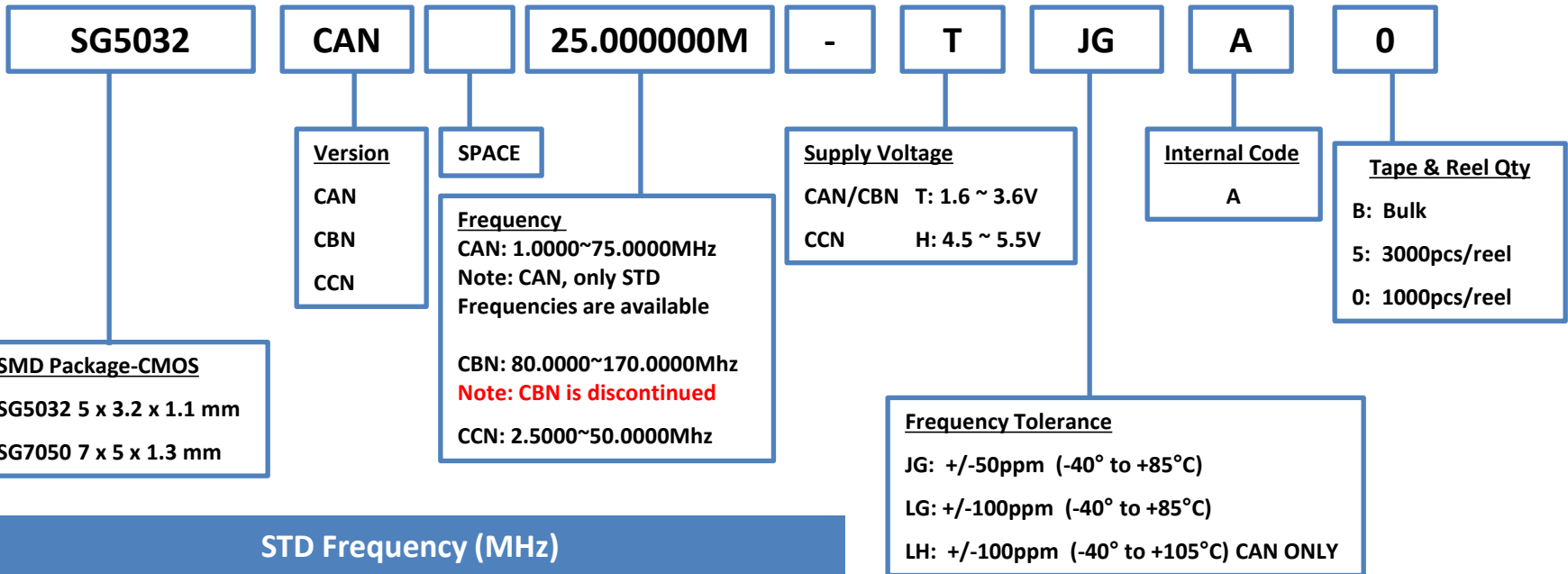

STD Frequency (MHz)			
4.0000	14.7456	25.0000	33.3333
8.0000	16.0000	26.0000	40.0000
10.0000	20.0000	27.0000	48.0000
12.0000	24.0000	32.0000	50.0000
12.2880	24.5760	33.3300	72.0000

Example: SG5032CAN 25.0000M-TJGA
JH is not available



For non-standard frequencies, please see SG-8018

Product Configuration System



Crystal Oscillators - SPXO

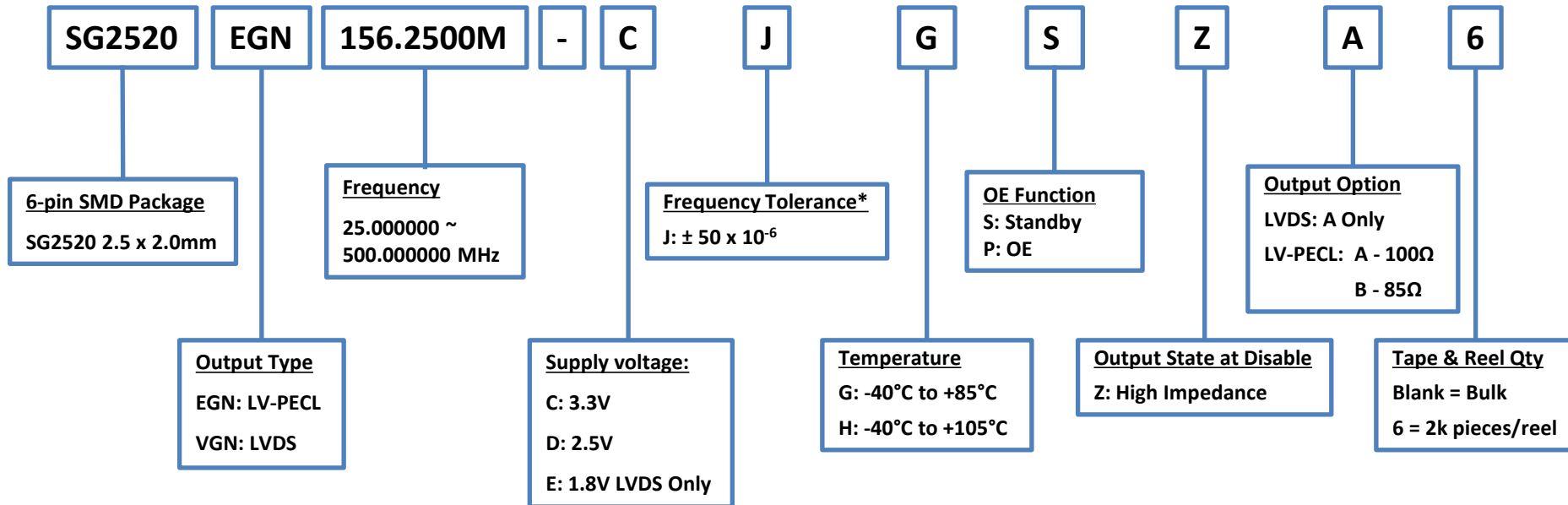

1. Slide 54 and 55 – The letter options for OE and o/p state at disable didn't match the valid options, so changed those.

* Please contact SEC for availability for a given temperature range

EPSON

Note: All packages are RoHS Compliant

Product Configuration System



Crystal Oscillators - SPXO

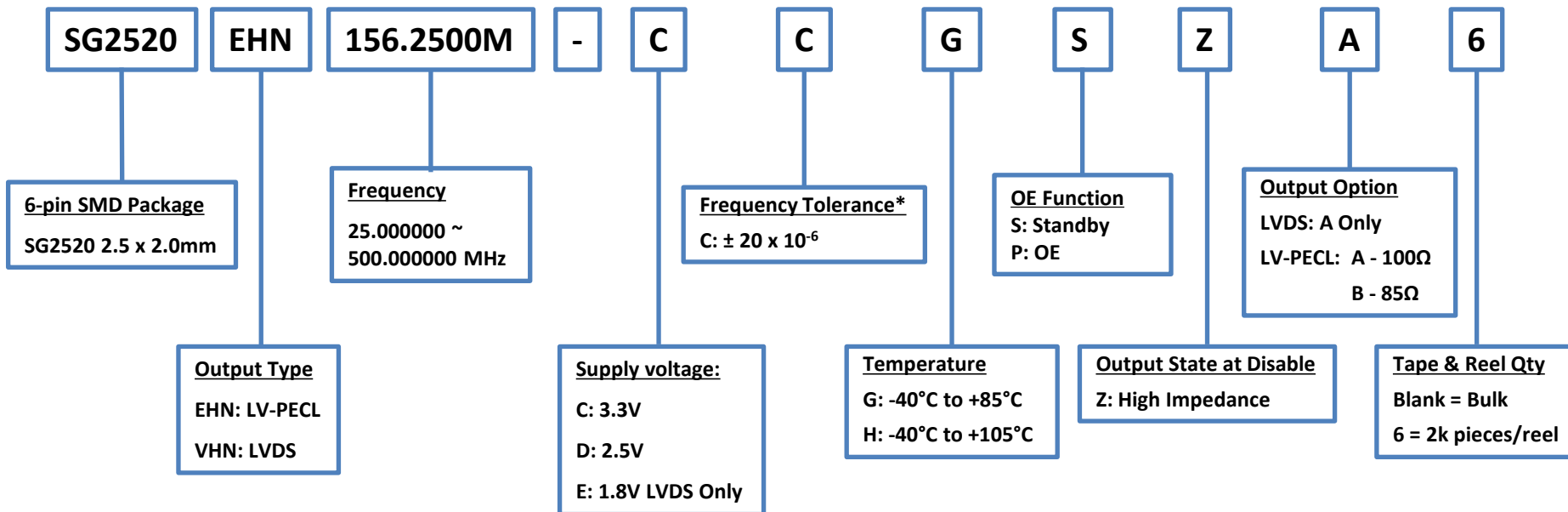

* Please contact SEC for availability for a given temperature range

EPSON

Note: All packages are RoHS Compliant

Product Configuration System



Crystal Oscillators - SPXO

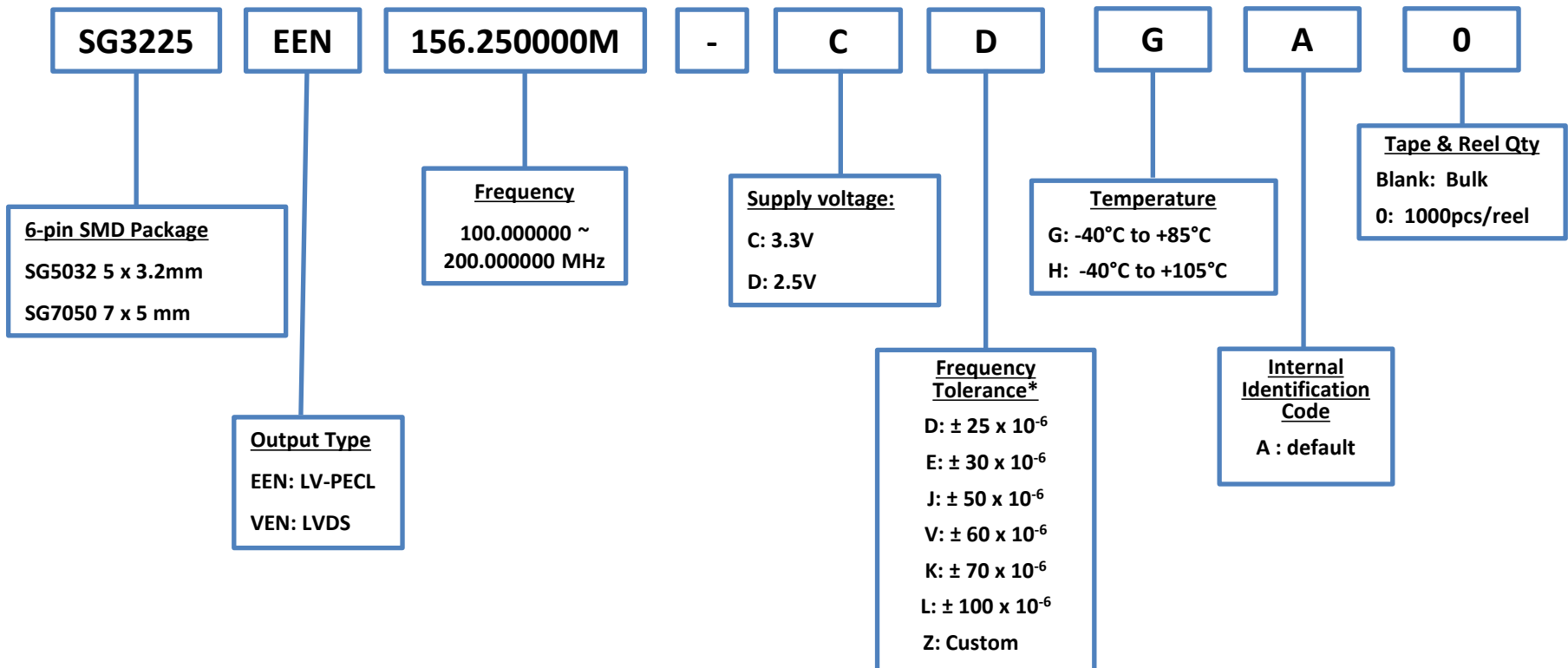

* Please contact SEC for availability for a given temperature range



Note: All packages are RoHS Compliant

Product Configuration System



Crystal Oscillators - SPXO

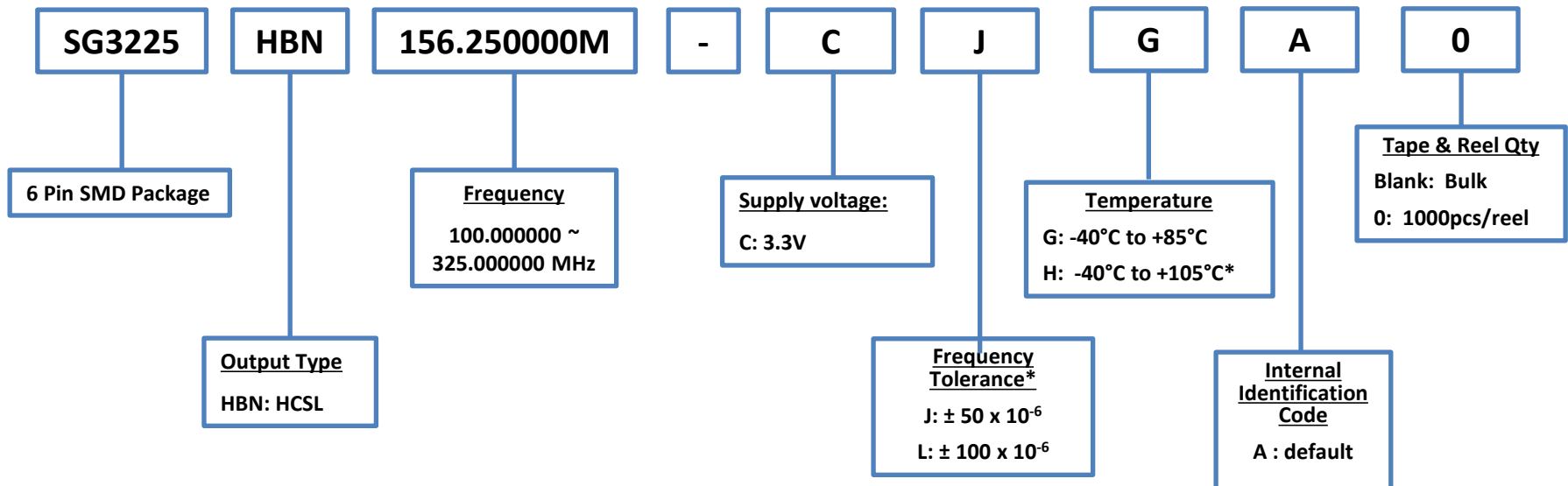

* Please contact SEC for availability for a given temperature range

Note: All packages are RoHS Compliant
*For 105C, contact Epson

Product Configuration System



Crystal Oscillators - SPXO

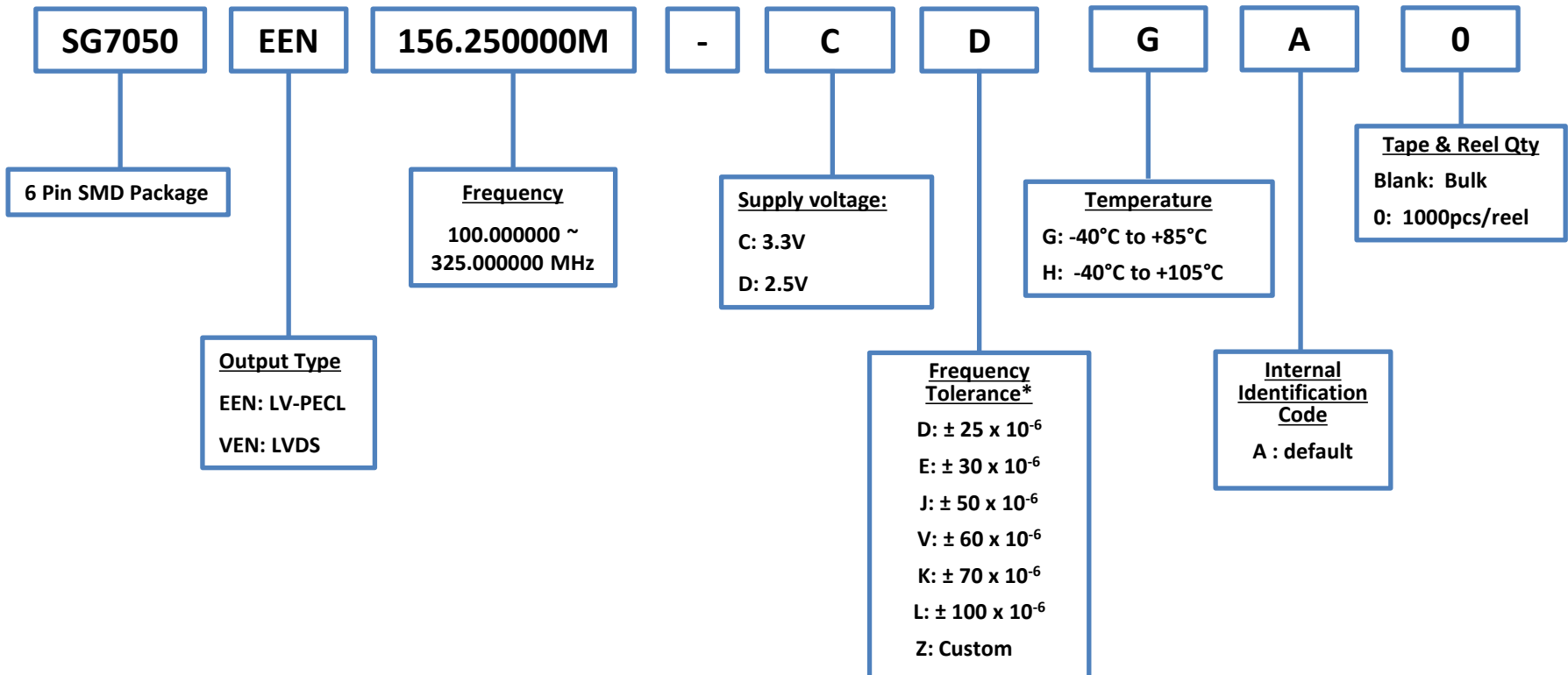

* Please contact SEC for availability for a given temperature range



Note: All packages are RoHS Compliant



Product Configuration System

Crystal Oscillators – SPXO

Output : LV-PECL, LVDS

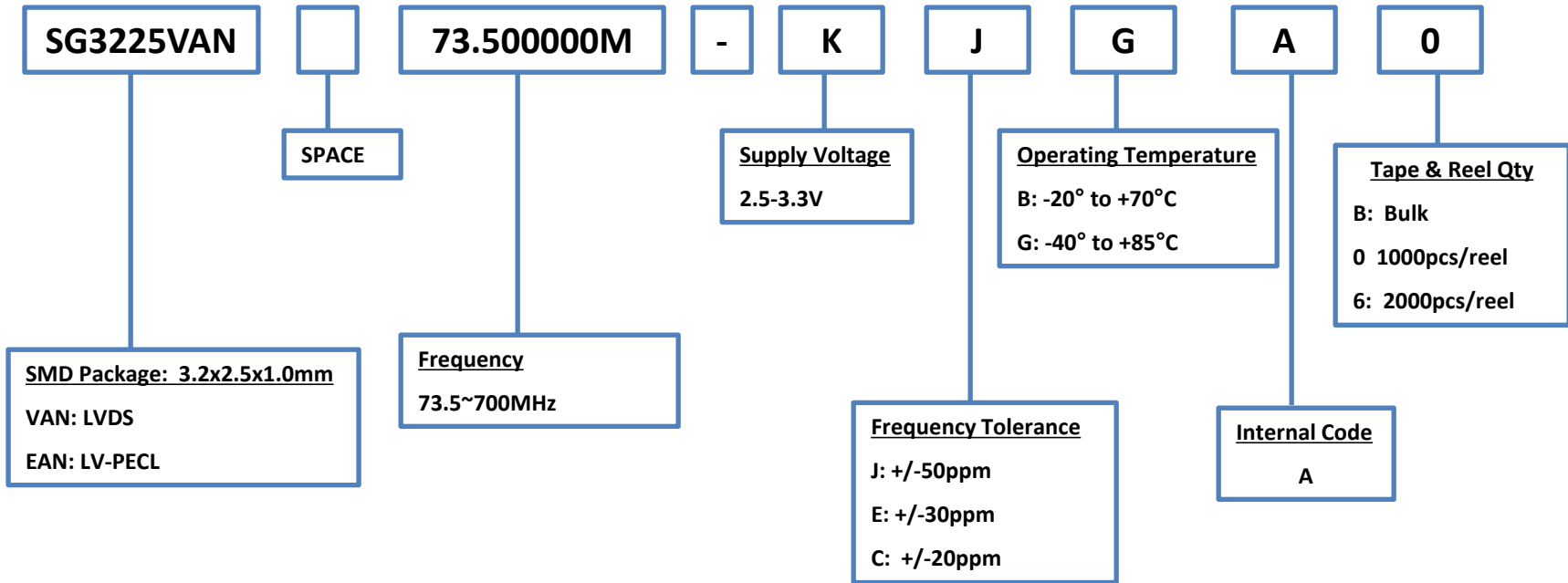

Example: SG3225EAN 73.500000M-KJGA
CG is not available



Product Configuration System

Crystal Oscillators – SPXO

Output : LV-PECL, LVDS

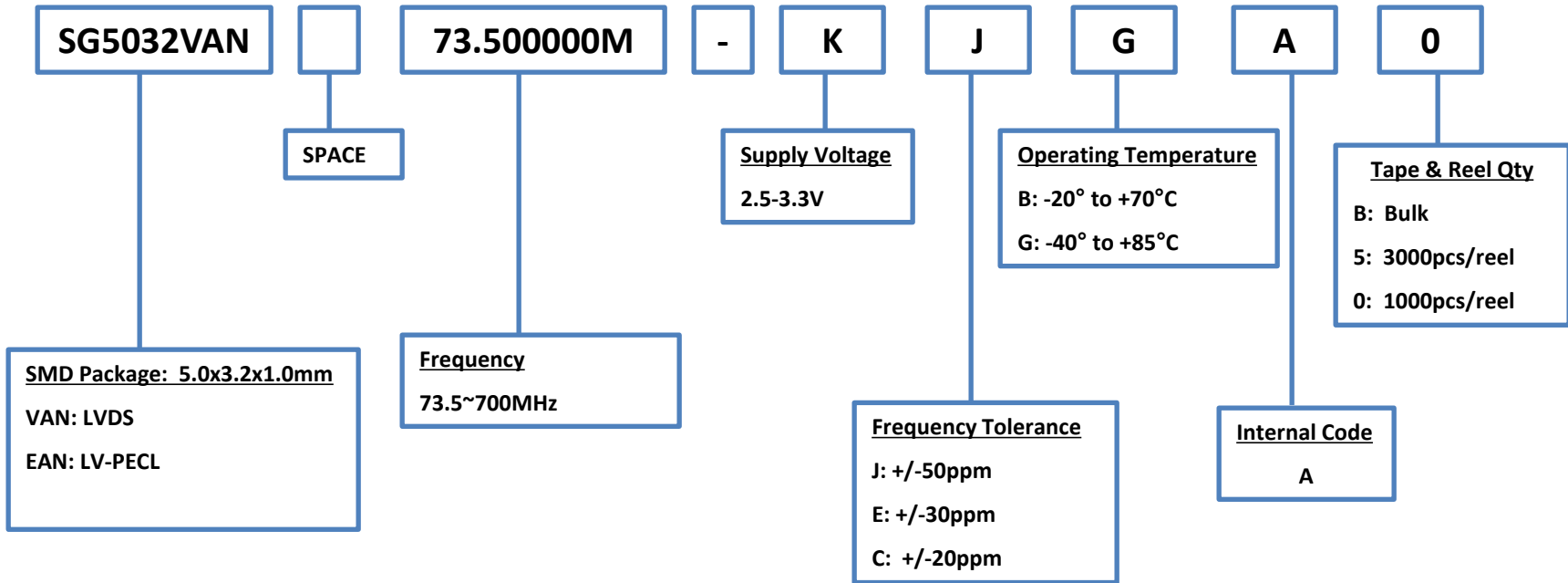

Example: SG5032EAN 73.500000M-KJGA
CG is not available



Product Configuration System

Crystal Oscillators – SPXO

Output : LV-PECL, LVDS

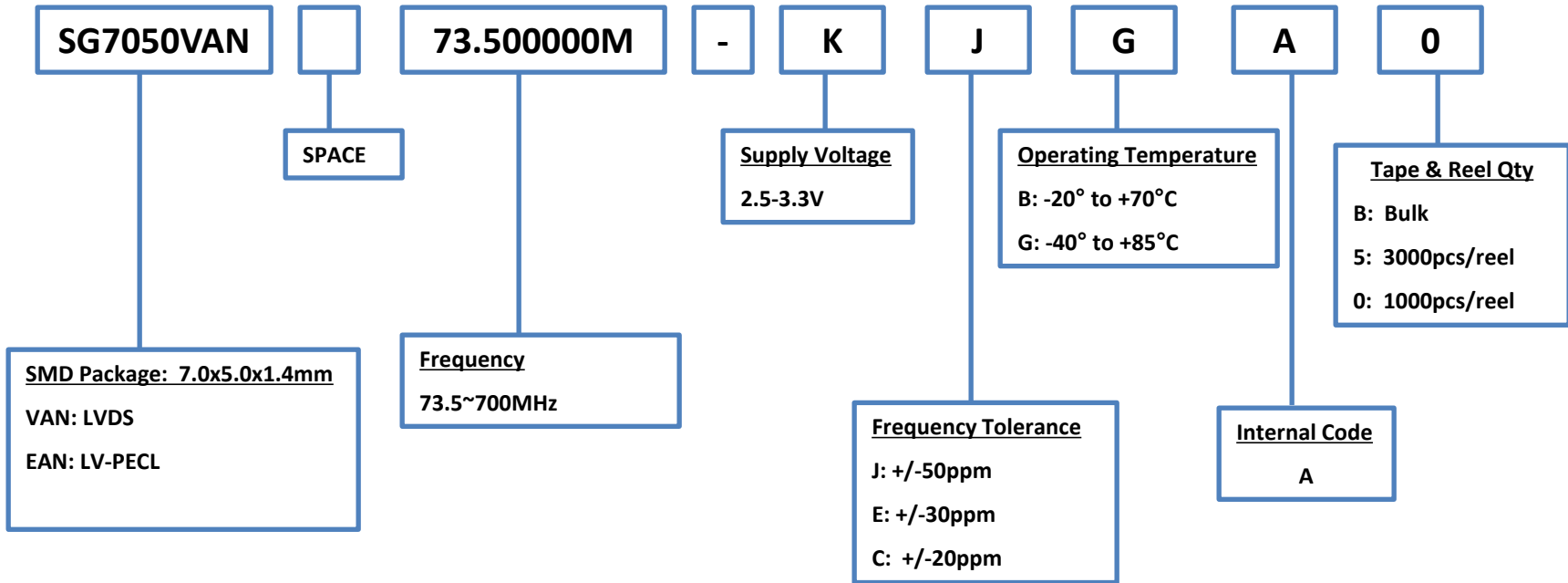

Example: SG7050EAN 73.500000M-KJGA
CG is not available

Product Configuration System



Crystal Oscillator - SPXO

Discontinued

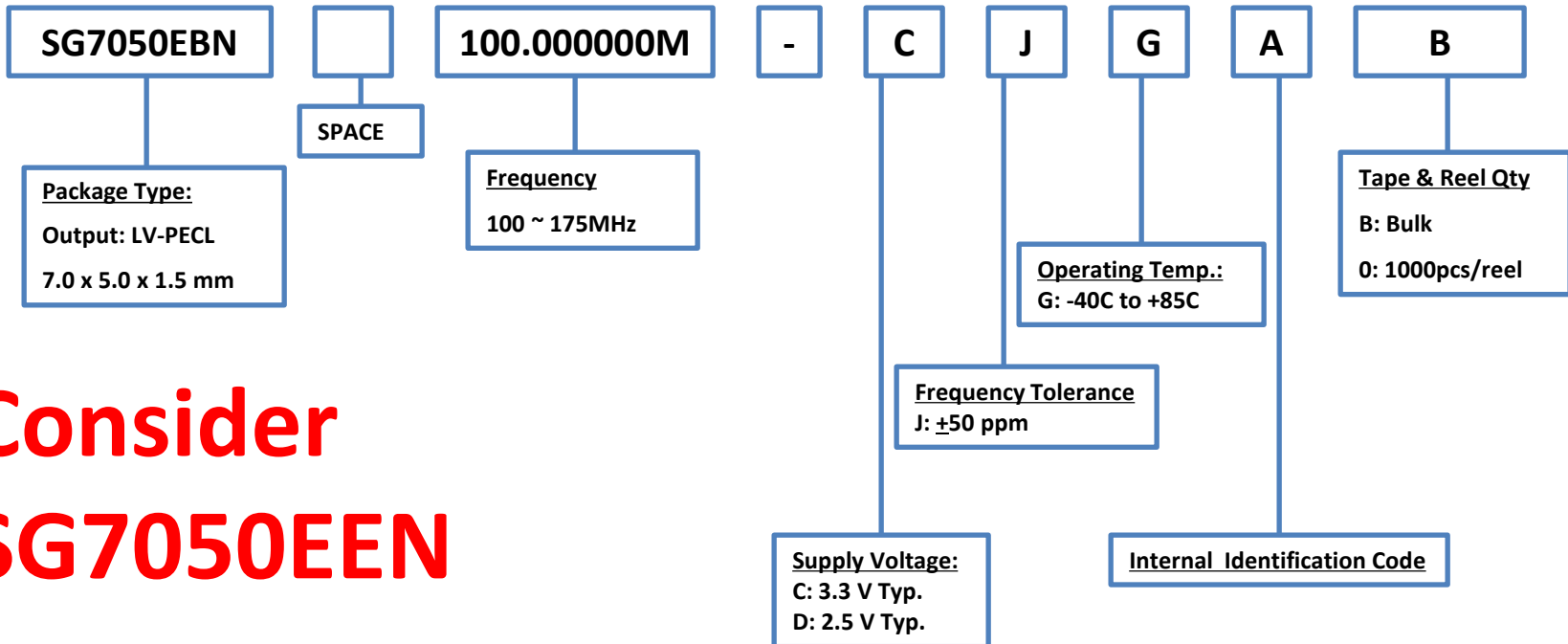

Consider SG7050EEN

NOTE:

Please contact us for requirements not listed in this specification.

EPSON

August 2022

Product Configuration System



Crystal Oscillators - SPXO

Discontinued

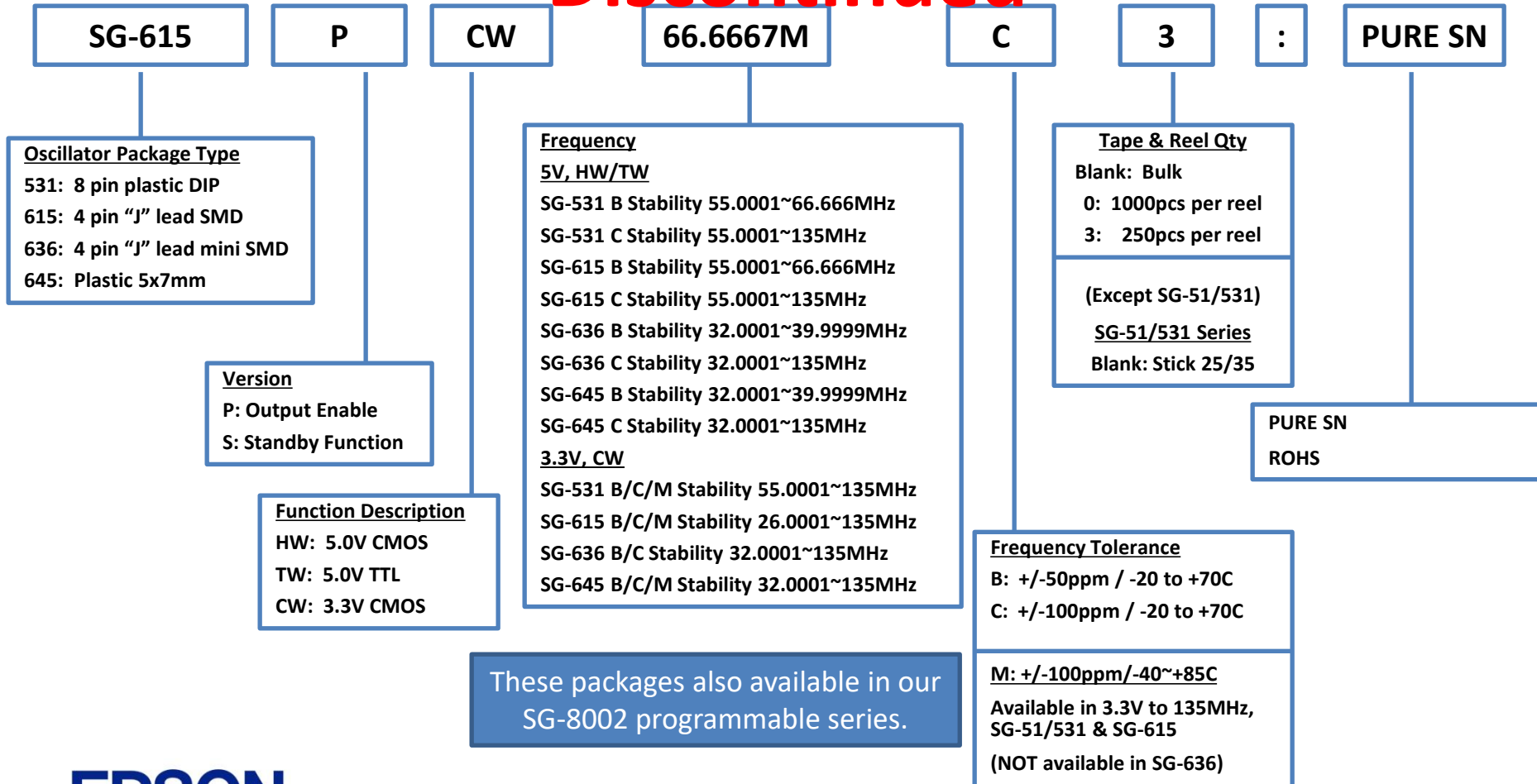

Product Configuration System



Crystal Oscillators - SPXO

Discontinued

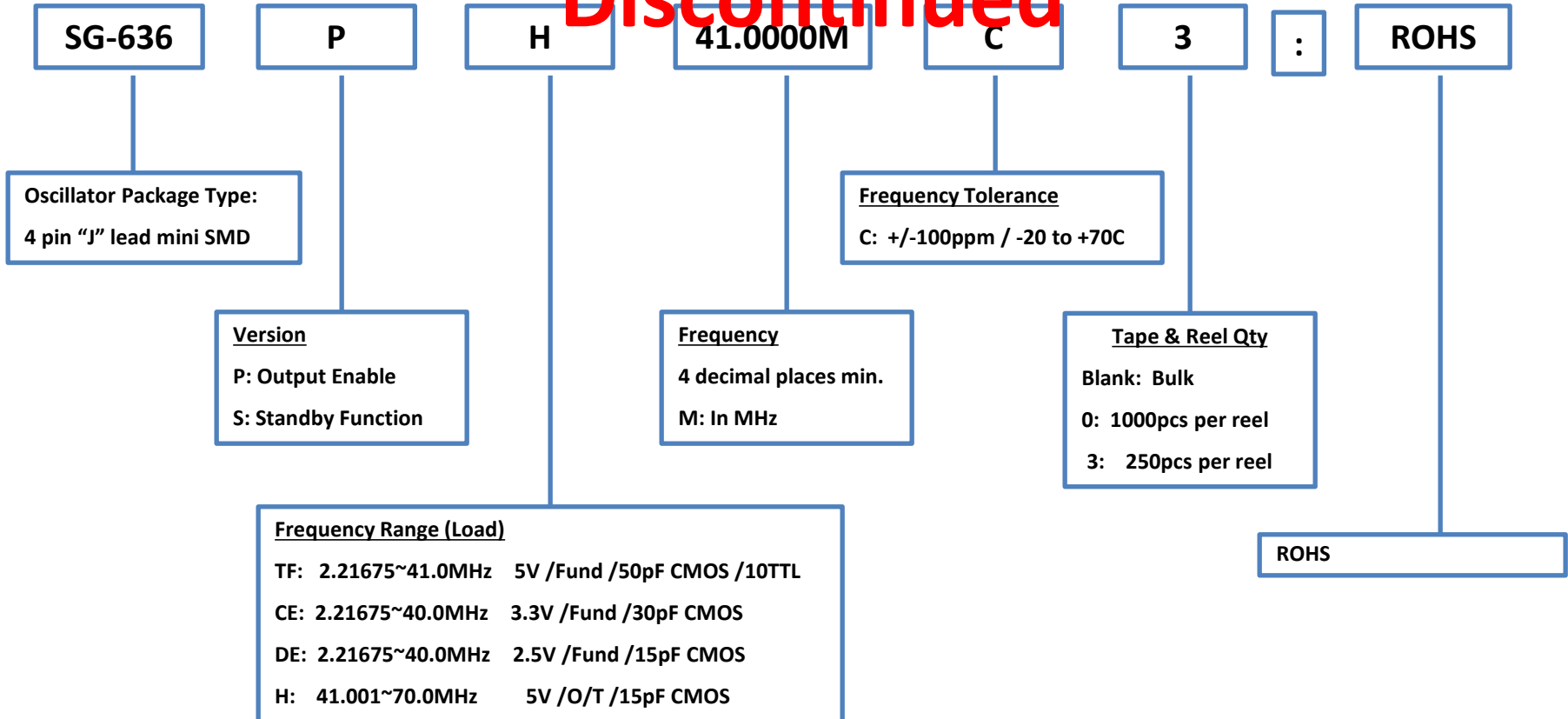

These packages also available in our SG-8002 programmable series.

Product Configuration System



Crystal Oscillators - SPXO

Discontinued

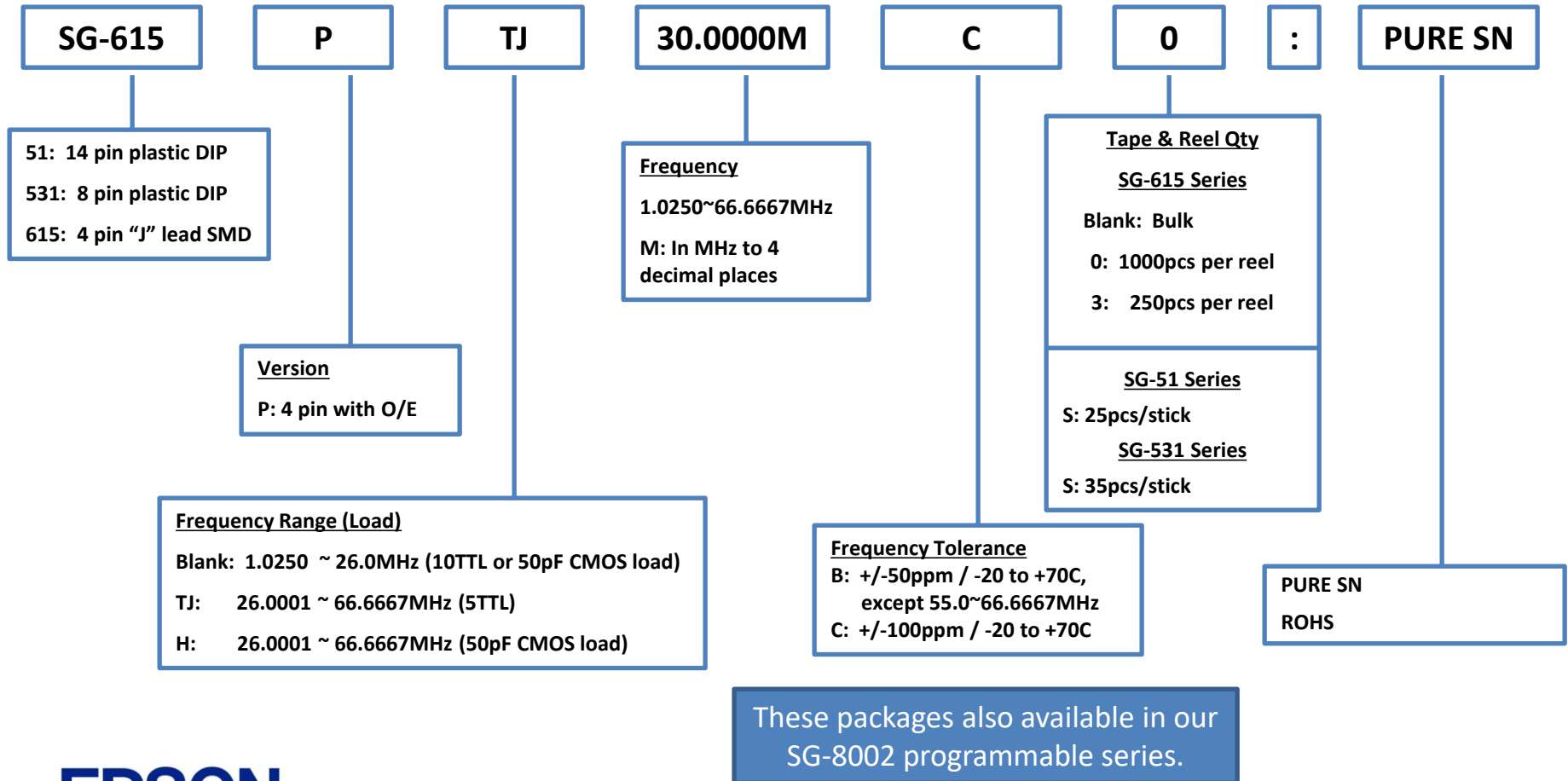

Product Configuration System



Crystal Oscillators - SPXO

Discontinued

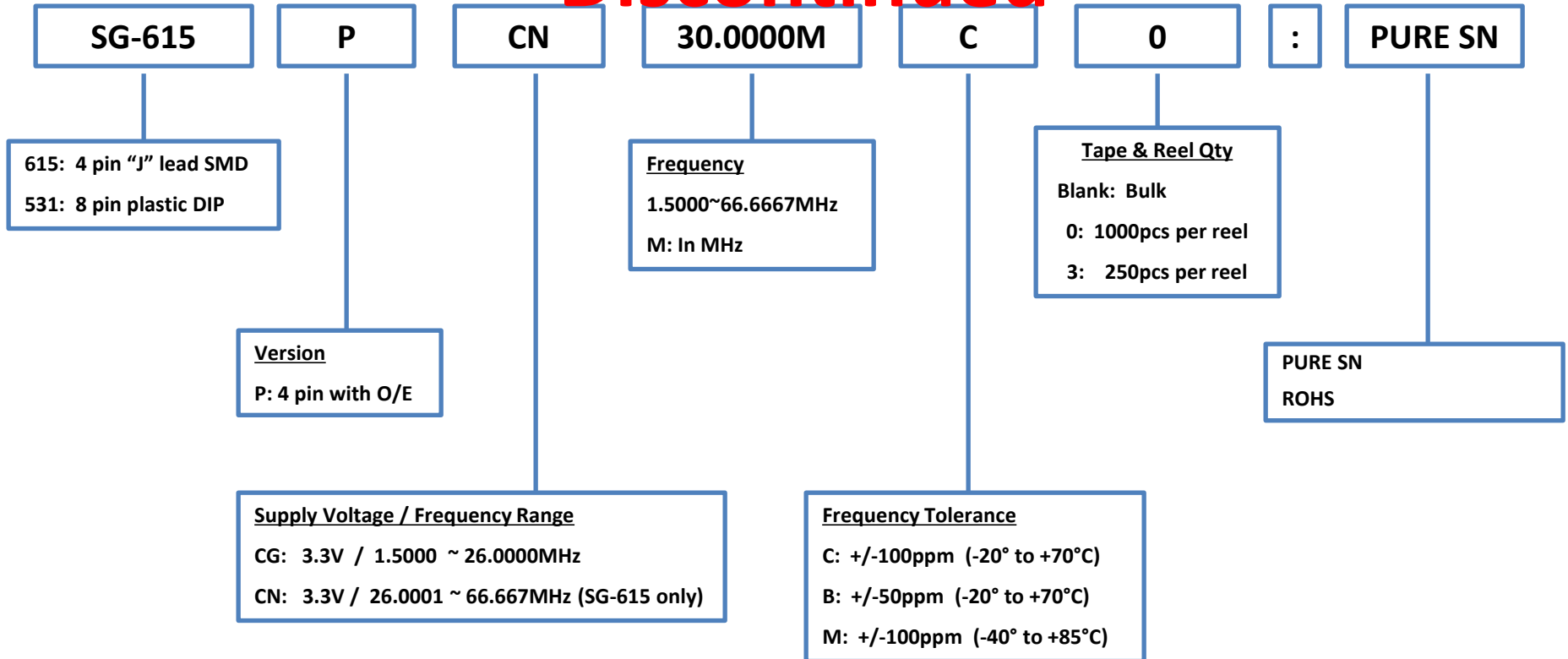

These packages also available in our SG-8002 programmable series.



Product Configuration System



Crystal Oscillators - SPXO

Discontinued

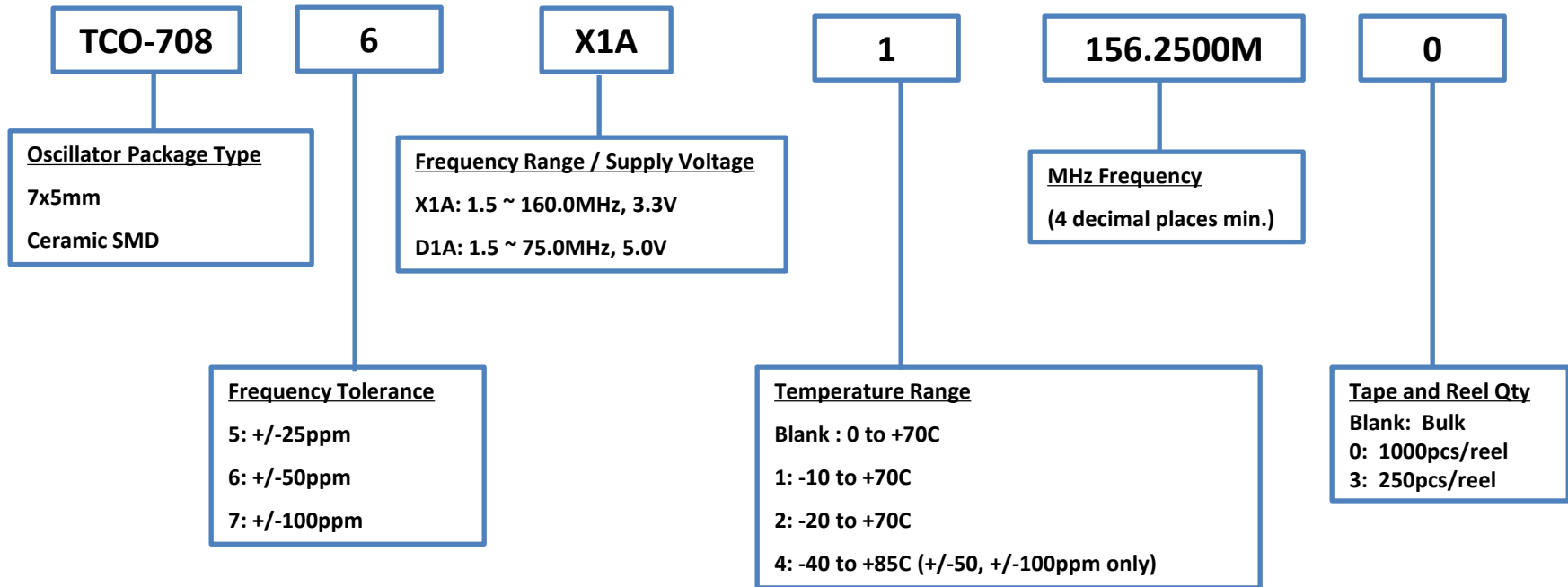

Product Configuration System



Crystal Oscillators - SPXO

Discontinued

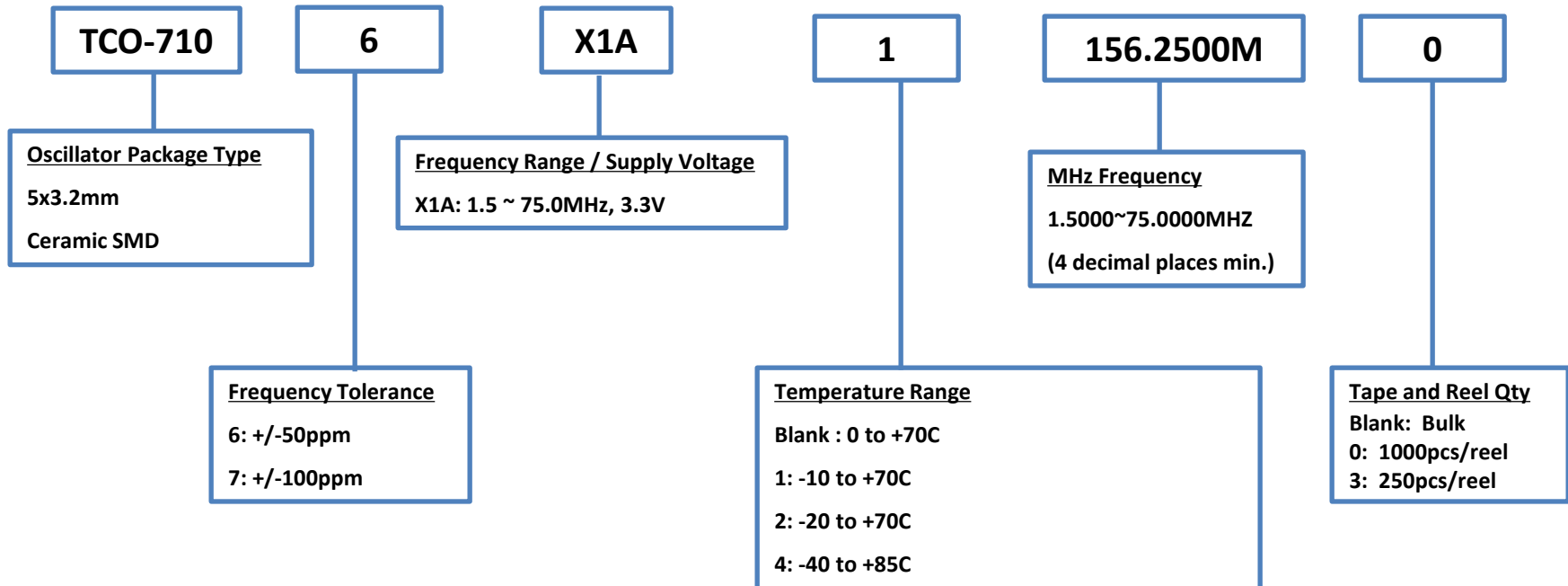

Product Configuration System



Crystal Oscillators - High Stability

Discontinued

