

Product Configuration Guide

REAL TIME CLOCKS

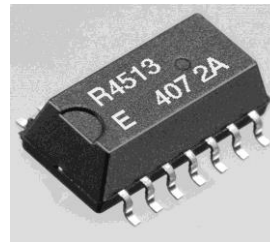

Product Configuration System

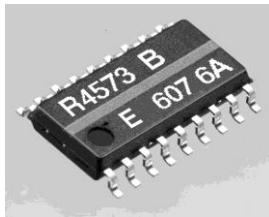

Real Time Clock Modules – I²C-Bus

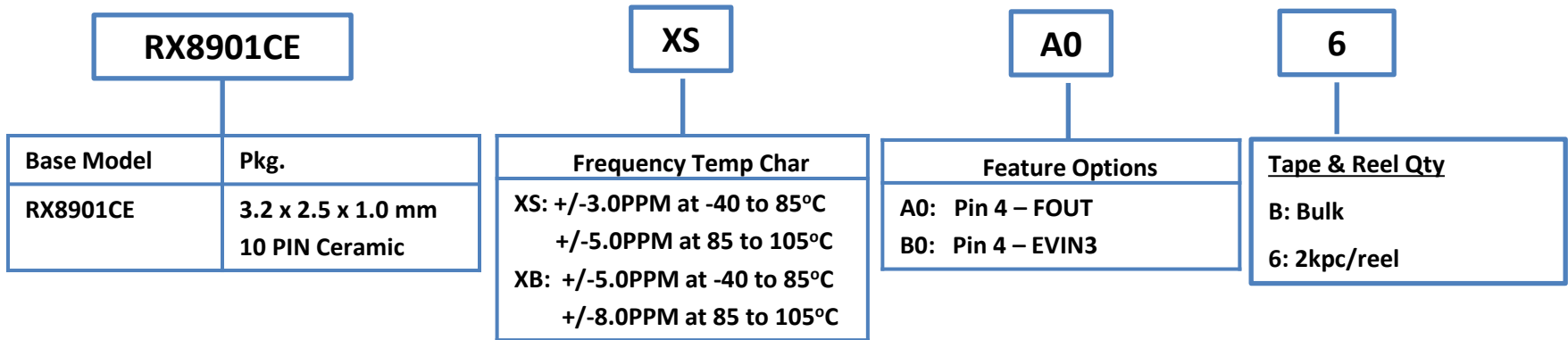

Examples:

RX8901CE XB A06

RX8901CE XS B06

NOTE:

Please contact us for requirements not listed in this specification.

Product Configuration System



Real Time Clock Modules – SPI-Bus

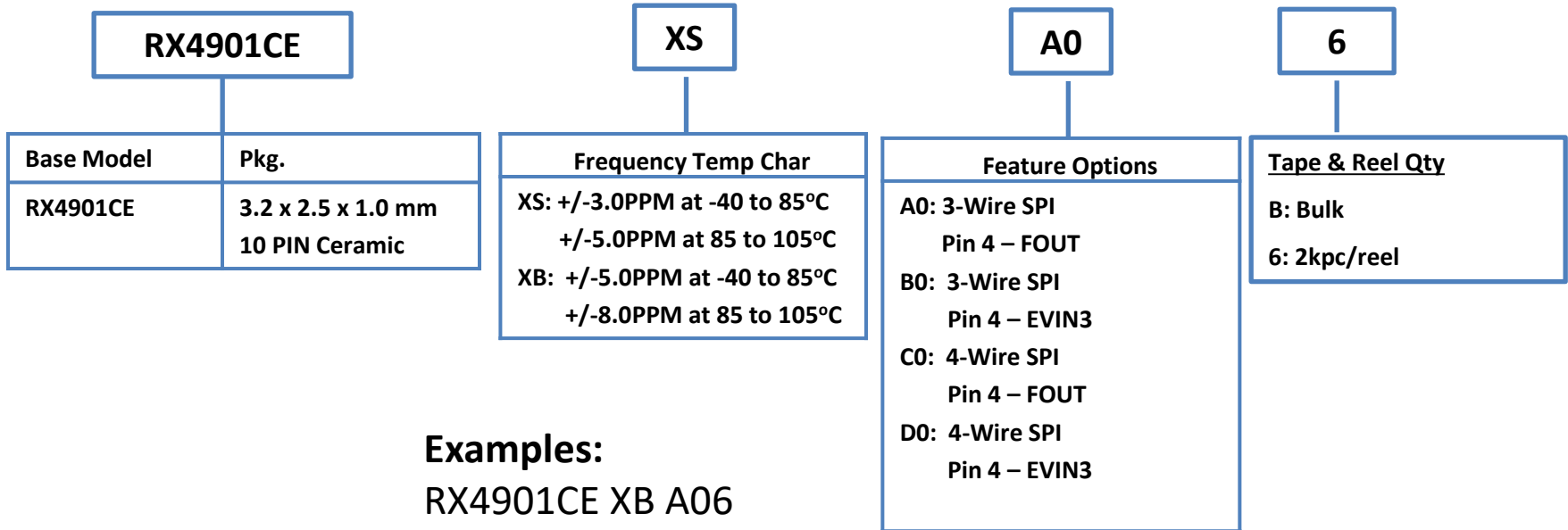

Examples:
 RX4901CE XB A06
 RX4901CE XS B06

NOTE:

Please contact us for requirements not listed in this specification.

Product Configuration System



Real Time Clock Modules – I²C-Bus, Automotive (AEC-Q100)

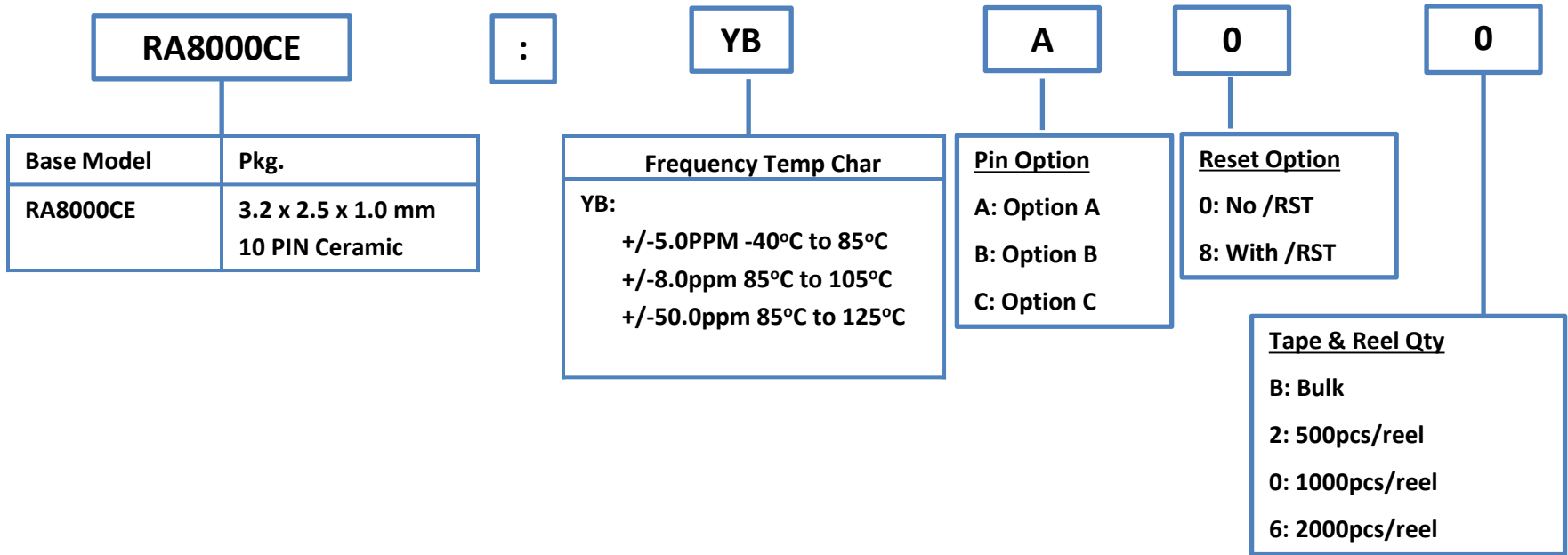

NOTE:

Please contact us for requirements not listed in this specification. Refer to DS for Pin and Reset options

Product Configuration System



Real Time Clock Modules – SPI-Bus, Automotive (AEC-Q100)

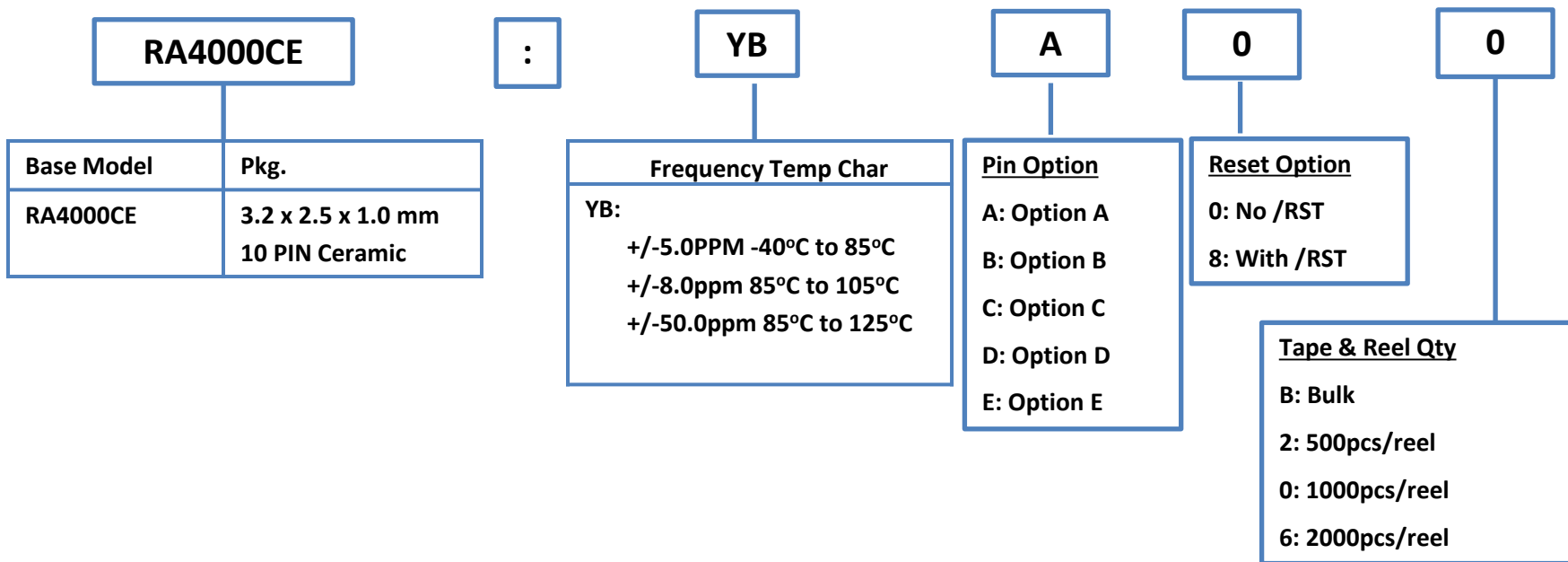

NOTE:
 Please contact us for requirements not listed in this specification. Refer to DS for Pin and Reset options

Product Configuration System



Real Time Clock Modules – I²C-Bus

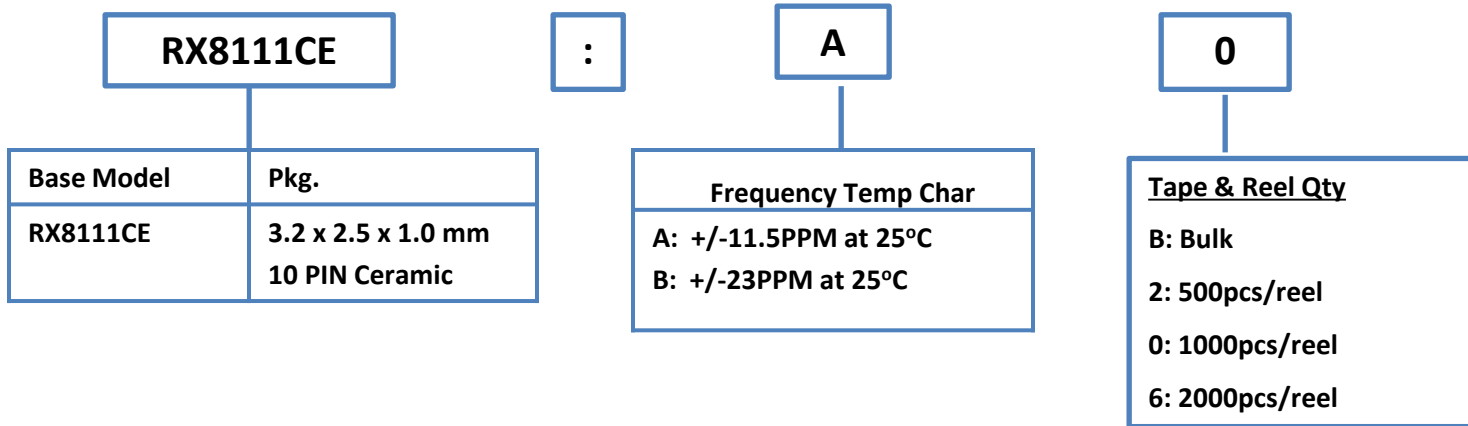

NOTE:

Please contact us for requirements not listed in this specification.

Product Configuration System



Real Time Clock Modules – SPI

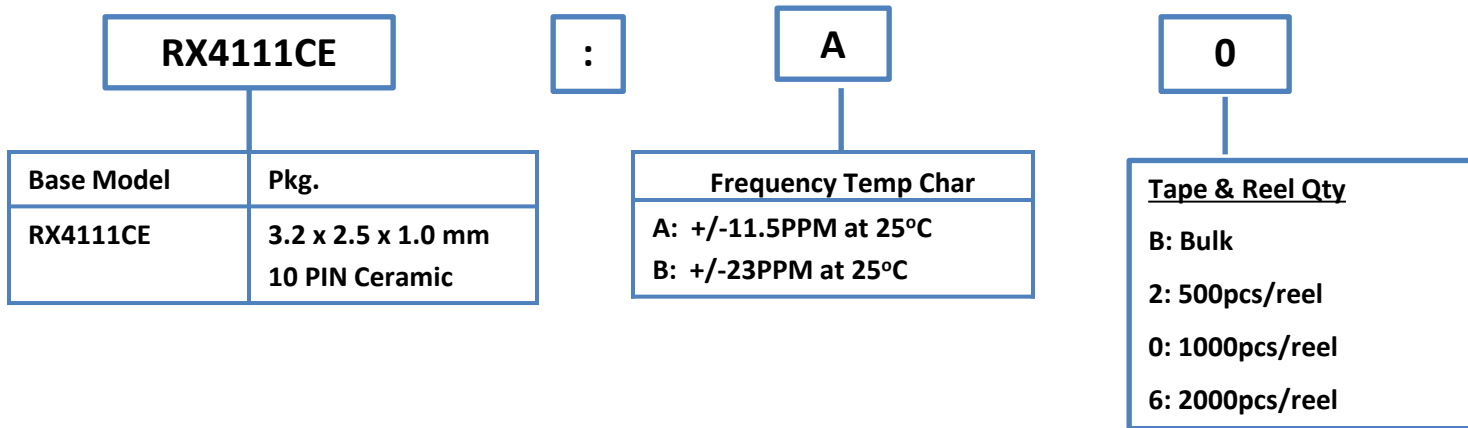

EPSON

August 2022

NOTE:

Please contact us for requirements not listed in this specification.

Product Configuration System



Real Time Clock Modules – I²C-Bus

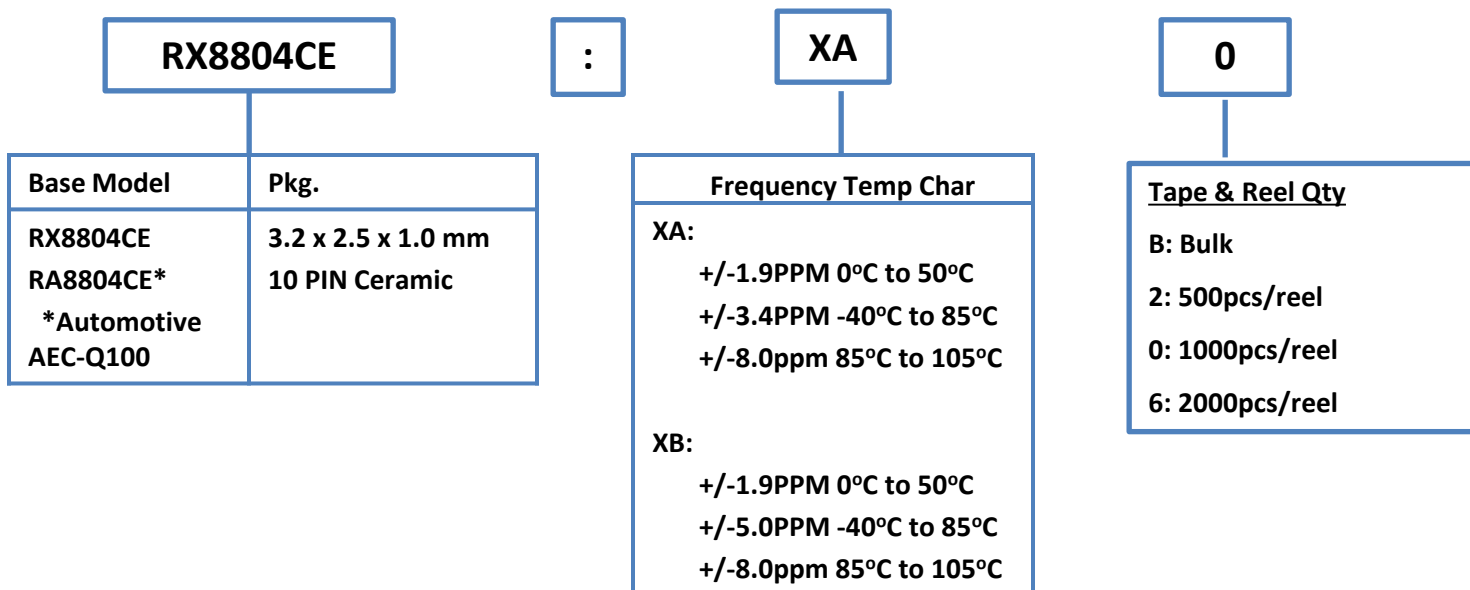

NOTE:

Please contact us for requirements not listed in this specification.

Product Configuration System



Real Time Clock Modules – Serial (3 Wire & 4 Wire)

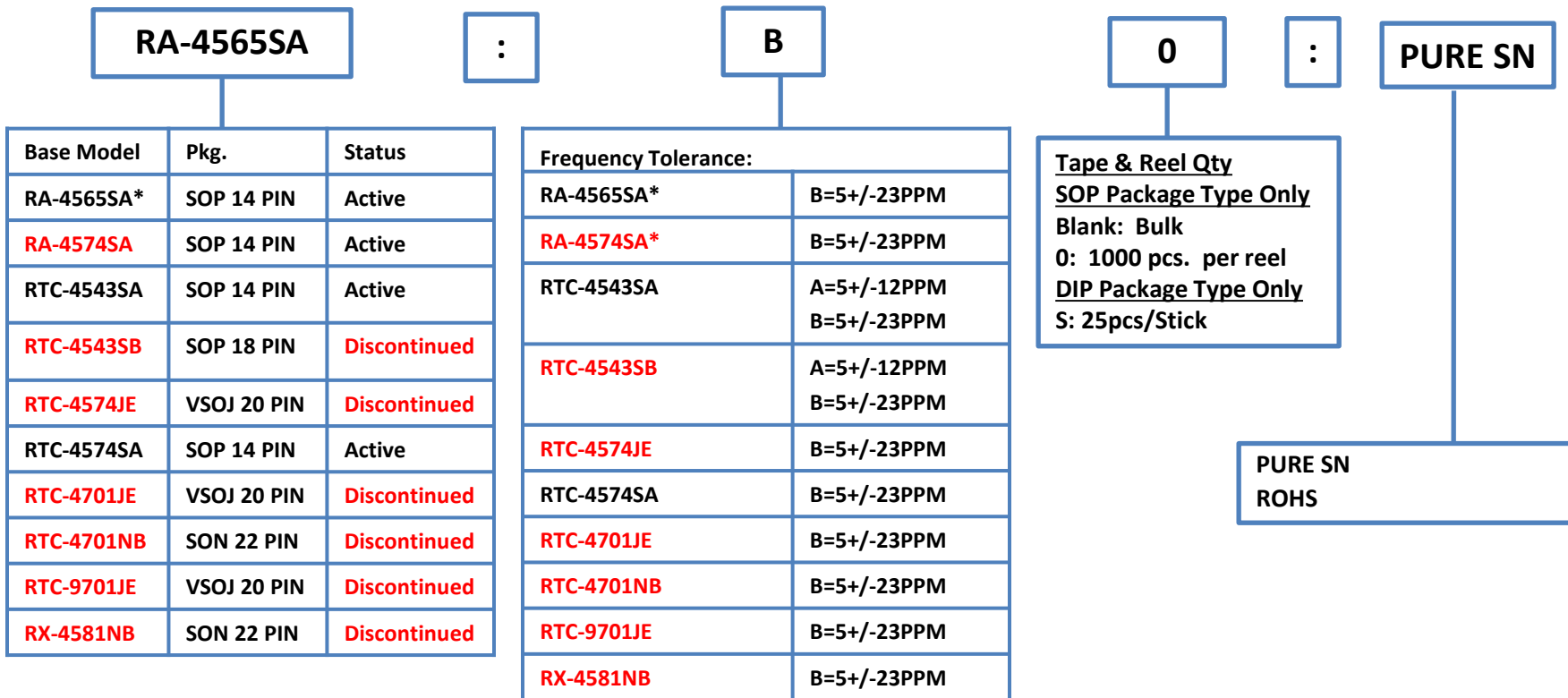

Note:
 SA packages in "PURE SN" is **DISCONTINUED** but "RoHS " is ACTIVE.
 Model P/N in RED font = **DISCONTINUED**
 *Automotive AEC-Q200



Product Configuration System



Real Time Clock Modules – Serial (3 Wire & 4 Wire)

RX-4571SA

:

B

0

:

PURE SN

Base Model	Pkg.	Status
RTC-4574NB	SON 22 PIN	Discontinued
RX-4045NB	SON 22 PIN	Active
RX-4045SA	SOP 14 PIN	Active
RX-4574LC	VSOJ 12 PIN	Active
RX-4575LC	VSOJ 12 PIN	Discontinued
RX-4571LC	VSOJ 12 PIN	Active
RX-4571NB	SON 22 PIN	Active
RX-4571SA	SOP 14 PIN	Active
RX-4801SA	SOP 14 PIN	Discontinued
RX-4803SA	SOP 14 PIN	Active
RX-4803LC	VSOJ 12 PIN	Active

Frequency Tolerance (Ta =+25 °C):	
RTC-4574NB	B=5+/-23PPM
RX-4045NB, RX-4045SA	AA=5+/-5PPM AC=0+/-5PPM
RX-4574LC	B=5+/-23PPM
RX-4575LC	B=5+/-23PPM
RX-4571LC	B=5+/-23PPM
RX-4571NB	B=5+/-23PPM
RX-4571SA	B=5+/-23PPM
RX-4801SA	Over -40 to +85 °C UB=+/-5PPM
RX-4803SA, RX-4803LC	Over -40 to +85 °C UA=+/-3.4PPM UB=+/-5PPM

Tape & Reel Qty
SOP Package Type Only
 Blank: Bulk
 0: 1000 pcs. per reel
DIP Package Type Only
 S: 25pcs/Stick

PURE SN
 Blank : Already RoHS Compliant

Note:
 All LC packages are already RoHS Compliant with "PURE SN".
 LC packages with "PURE SN" are DISCONTINUED
 *RX-4575LC - Sn-Ag Plating NOT PURE SN
 Model P/N in RED font = DISCONTINUED



Product Configuration System



Real Time Clock Modules – I²C-Bus

RX-8581SA

:

B

0

:

PURE SN

Base Model	Pkg.	Status
RA-8565SA*	SOP 14 PIN	Active
RX-8025NB	SON 22 PIN	Active
RX-8025SA	SOP 14 PIN	Active
RX-8564LC	VSOJ 12 PIN	Active
RX-8571SA	SOP 14 PIN	Active
RX-8571NB	SON 22 PIN	Active
RX-8571LC	VSOJ 12 PIN	Active
RX-8581JE	VSOJ 20 PIN	Discontinued
RX-8581NB	SON 22 PIN	Discontinued
RX-8581SA	SON 14 PIN	Active
RX-8731LC	VSOJ 12 PIN	Active

Frequency Tolerance:

RA-8565SA*	B=5+/-23PPM
RX-8025NB	AA=5+/-5PPM
RX-8025SA	AA=5+/-5PPM
RX-8564LC	B=5+/-23PPM
RX-8571SA	B=5+/-23PPM
RX-8571NB	B=5+/-23PPM
RX-8571LC	B=5+/-23PPM
RX-8581JE	B=5+/-23PPM
RX-8581NB	B=5+/-23PPM
RX-8581SA	B=5+/-23PPM
RX-8731LC	B=5+/-23PPM

Tape & Reel Qty
SOP Package Type Only
 Blank: Bulk
 0: 1000 pcs. per reel
DIP Package Type Only
 S: 25pcs/Stick

PURE SN
 Blank : Already RoHS Compliant

Note:
 All LC packages are already RoHS Compliant with “PURE SN”
Model P/N in RED font = DISCONTINUED
 *Automotive AEC-Q200



Product Configuration System



Real Time Clock Modules – I²C-Bus

RA-8581SA

:

B

0

:

PURE SN

Base Model	Pkg.	Status
RA-8581SA*	SOP 14 PIN	Discontinued
RTC-8564JE	VSOJ 20 PIN	Active
RTC-8564NB	SON 22 PIN	Active
RX8010SJ	SOP 8 PIN	Active
RA4803SA*	SOP 14 PIN	Active
RA8803SA*	SOP 14 PIN	Active
RX8900SA	SOP 14 PIN	Active
RA8900SA*	SOP 14 PIN	Active
RX8900CE	3.2x2.5mm	Active
RA8900CE*	10 PIN Ceramic	Active

Frequency Tolerance:

RA-8581SA*	B=5+/-23PPM
RTC-8564JE	B=5+/-23PPM
RTC-8564NB	B=5+/-23PPM
RX8010SA	B=5+/-23PPM
RX4803SA RA4803SA* RX8803SA	UA= +/-3.4PPM -40°C to 85°C UB= +/-5.0PPM -40°C to 85°C UC=+/- 5PPM -30°C to 70°C AA=5+/-5PPM 25°C
RX8900SA RA8900SA* and RX8900CE RA8900CE*	UA=+/-3.4PPM -40°C to 85°C UB=+/-5PPM -40°C to 85°C UC=+/-5PPM -30°C to 70°C

Tape & Reel Qty

SOP Package Type Only
B: Bulk
0: 1000 pcs. per reel

Blank : CE Package

RX8010SJ: PURE SN
RA4803SA: PURE SN
RX8803SA: PURE SN
RX8900SA: PURE SN
RA-8581SA: ROHS or PURE SN
RTC-8564JE: ROHS
RTC-8564NB: ROHS or PURE SN

Note:

Model P/N in RED font = DISCONTINUED

*Automotive AEC-Q200

Product Configuration System



Real Time Clocks – Parallel 4-bit

Discontinued

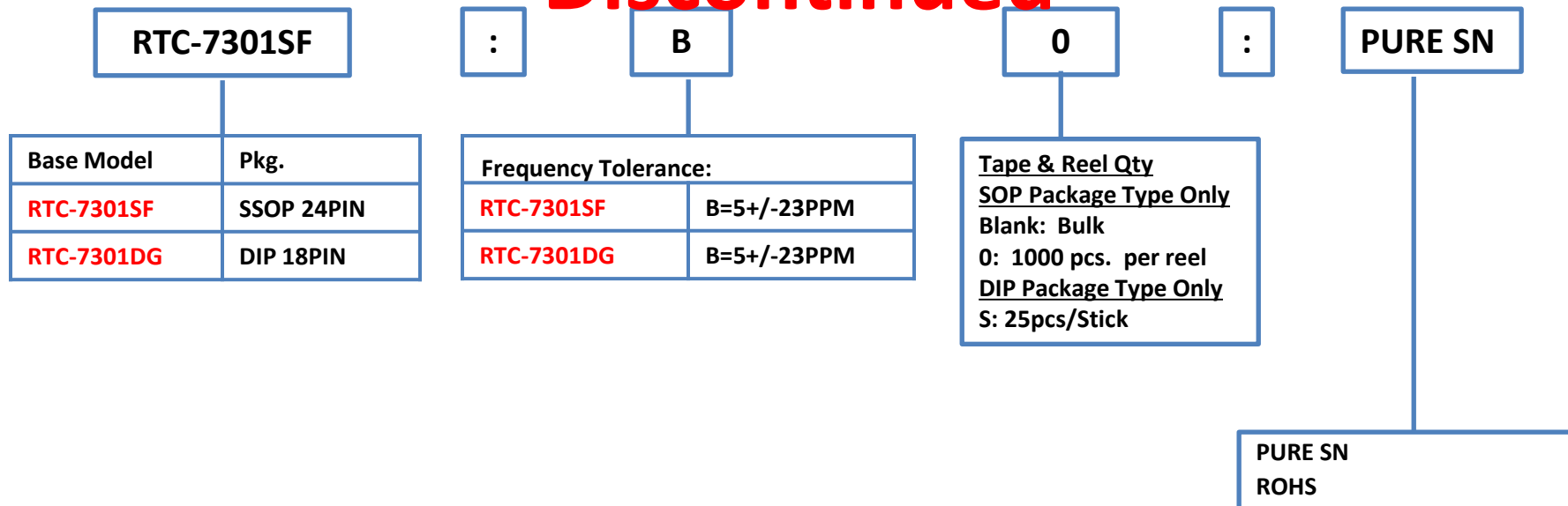

Note:

Model P/N in RED font = DISCONTINUED

Product Configuration System



Real Time Clocks – Parallel 4-bit

Discontinued

RTC-72423A

Base Model	Pkg.	Freq. Tolerance
RTC-62421A	DIP 18PIN	+/-10ppm
RTC-62421B	DIP 18PIN	+/-50ppm
RTC-72421A	DIP 18PIN	+/-10ppm
RTC-72421B	DIP 18PIN	+/-50ppm
RTC-72423A	SSOP 24PIN	+/-20ppm
RTC-72423B	SSOP 24PIN	+/-50ppm

0

:

PURE SN

Tape & Reel Qty
SOP Package Type Only
 Blank: Bulk
 0: 1000 pcs. per reel
DIP Package Type Only
 S: 25pcs/Stick

PURE SN
 ROHS



Note:
 Model P/N in RED font = DISCONTINUED

Product Configuration System



Real Time Clock Modules – I²C-Bus and SPI

